



650V SuperJunction Power MOSFET

Features

- Extremely Low Gate Charge
- Excellent Output Capacitance (C_{oss}) Profile
- Fast Switching Capability
- 100% UIS Tested, 100% R_g Tested
- Pb-free Lead Plating
- Halogen-free and RoHS-compliant

Product Summary

Parameter	Value	Unit
V_{DS}	650	V
$V_{GS(th_Typ)}$	3.5	V
I_D (@ $V_{GS} = 10V$) ⁽¹⁾	4.0	A
$R_{DS(ON_Typ)}$ (@ $V_{GS} = 10V$)	895	m Ω
$E_{oss@400V}$	0.68	μJ

Applications

- Telecom / Server Power Supplies
- Industrial Power Supplies
- UPS / Solar
- Lighting / Charger / Adapter

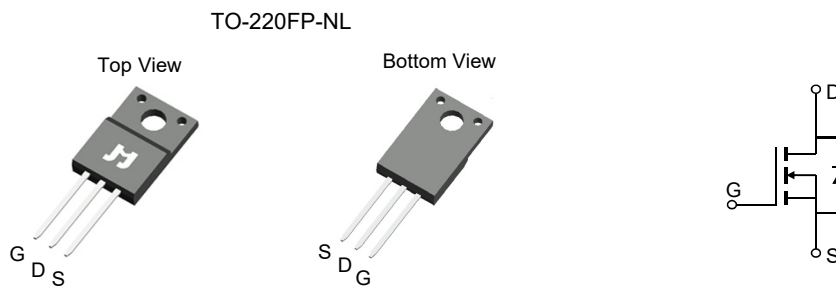

Ordering Information

Device	Package	# of Pins	Marking	MSL	T_J (°C)	Media	Quantity (pcs)
JMH65R980ACFP-U	TO-220FP-NL	3	H65R980A	NA	-55 to 150	Tube	50

Absolute Maximum Ratings (@ $T_A = 25^\circ C$ unless otherwise specified)

Parameter	Symbol	Value	Unit
Drain-to-Source Voltage	V_{DS}	650	V
Gate-to-Source Voltage	V_{GS}	± 20	V
Continuous Drain Current ⁽¹⁾	I_D	$T_C = 25^\circ C$	4.0
		$T_C = 100^\circ C$	2.4
Pulsed Drain Current ⁽²⁾	I_{DM}	16.0	A
Avalanche Current ⁽³⁾	I_{AS}	4.0	A
Avalanche Energy ⁽³⁾	E_{AS}	80	mJ
Power Dissipation ⁽⁴⁾	P_D	$T_C = 25^\circ C$	37
		$T_C = 100^\circ C$	14.7
Junction & Storage Temperature Range	T_J, T_{STG}	-55 to 150	$^\circ C$

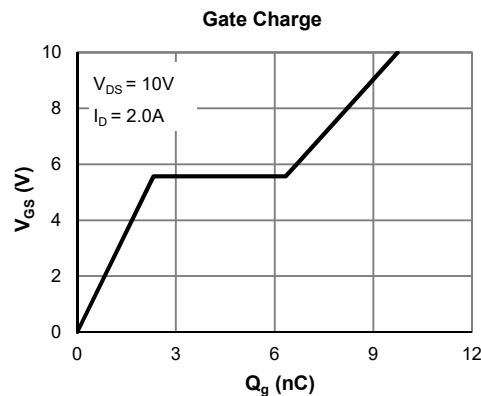
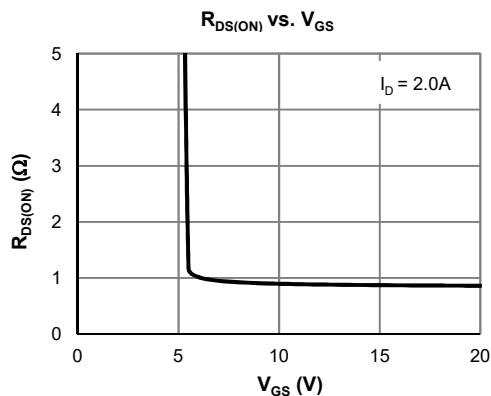



Electrical Characteristics (@ T_J = 25°C unless otherwise specified)

Parameter	Symbol	Conditions	Min.	Typ.	Max.	Unit
STATIC PARAMETERS						
Drain-Source Breakdown Voltage	V _{(BR)DSS}	I _D = 250μA, V _{GS} = 0V	650			V
Zero Gate Voltage Drain Current	I _{DSS}	V _{DS} = 650V, V _{GS} = 0V			1.0	μA
Gate-Body Leakage Current	I _{GSS}	V _{DS} = 0V, V _{GS} = ±20V			±100	nA
Gate Threshold Voltage	V _{GS(th)}	V _{DS} = V _{GS} , I _D = 250μA	2.5	3.5	4.5	V
Static Drain-Source ON-Resistance	R _{DS(ON)}	V _{GS} = 10V, I _D = 2.0A		895	980	mΩ
Diode Forward Voltage	V _{SD}	I _S = 1A, V _{GS} = 0V		0.75		V
Diode Continuous Current	I _S	T _C = 25°C			10	A
DYNAMIC PARAMETERS ⁽⁵⁾						
Input Capacitance	C _{ISS}	V _{GS} = 0V, V _{DS} = 100V, f = 1MHz		333		pF
Output Capacitance	C _{OSS}	V _{GS} = 0V, V _{DS} = 100V, f = 1MHz		20		pF
Effective output capacitance, energy related	C _{O(er)}	V _{GS} =0V, V _{DS} =0...400V		8.6		pF
Effective output capacitance, time related	C _{O(tr)}	ID=constant, V _{GS} =0V, V _{DS} =0...400V		36		pF
Reverse Transfer Capacitance	C _{rss}	V _{GS} = 0V, V _{DS} = 100V, f = 1MHz		2.5		pF
Gate Resistance	R _g	f = 1MHz		1.2		Ω
SWITCHING PARAMETERS ⁽⁵⁾						
Total Gate Charge (@ V _{GS} = 10V)	Q _g	V _{GS} = 0 to 10V		9.7		nC
Gate Source Charge	Q _{gs}	V _{DS} = 400V, I _D = 2.0A		2.3		nC
Gate Drain Charge	Q _{gd}	V _{DS} = 400V, I _D = 2.0A		4.0		nC
Turn-On DelayTime	t _{D(on)}	V _{GS} = 10V, V _{DS} = 400V		10.0		ns
Turn-On Rise Time	t _r	R _L = 200Ω, R _{GEN} = 12Ω		18.6		ns
Turn-Off DelayTime	t _{D(off)}	R _L = 200Ω, R _{GEN} = 12Ω		25		ns
Turn-Off Fall Time	t _f	R _L = 200Ω, R _{GEN} = 12Ω		83		ns
Body Diode Reverse Recovery Time	t _{rr}	I _F = 2.0A, di/dt = 100A/μs		152		ns
Body Diode Reverse Recovery Charge	Q _{rr}	I _F = 2.0A, di/dt = 100A/μs		1.1		μC
Peak Diode Recovery Voltage Slope	dv/dt	I _F ≤ 2A, di/dt = 200A/μs, V _{DS} = 400V		15.0		V/ns
MOSFET dv/dt Ruggedness	dv/dt	V _{DS} = 0...400V		50		V/ns

Thermal Performance

Parameter	Symbol	Typ.	Max.	Unit
Thermal Resistance, Junction-to-Ambient	R _{θJA}	55	68	°C/W
Thermal Resistance, Junction-to-Case	R _{θJC}	3.4	4.0	°C/W

Notes:

1. Computed continuous current assumes the condition of T_{J_max} while the actual continuous current depends on the thermal & electro-mechanical application board design.
2. This single-pulse measurement was taken under T_{J_max} = 150°C.
3. This single-pulse measurement was taken under the following condition [L = 10mH, V_{GS} = 10V, V_{DS} = 50V] while its value is limited by T_{J_max} = 150°C.
4. The power dissipation P_D is based on T_{J_max} = 150°C.
5. This value is guaranteed by design hence it is not included in the production test.

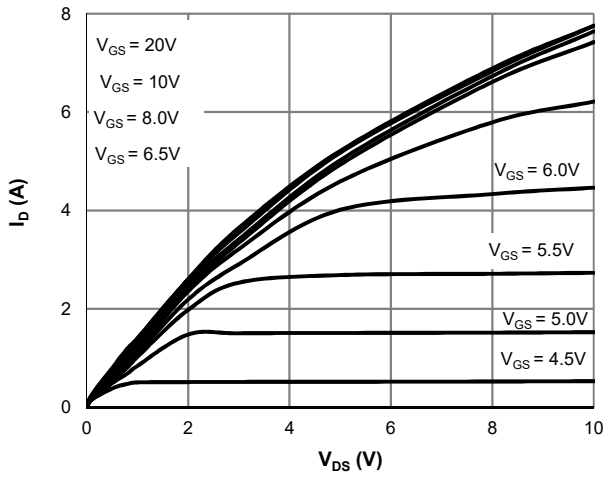
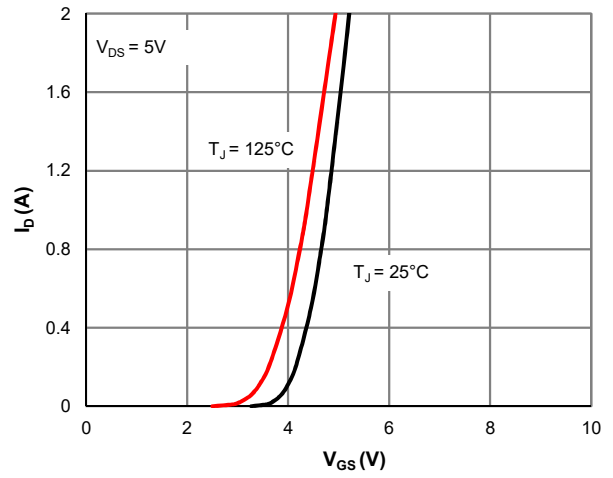
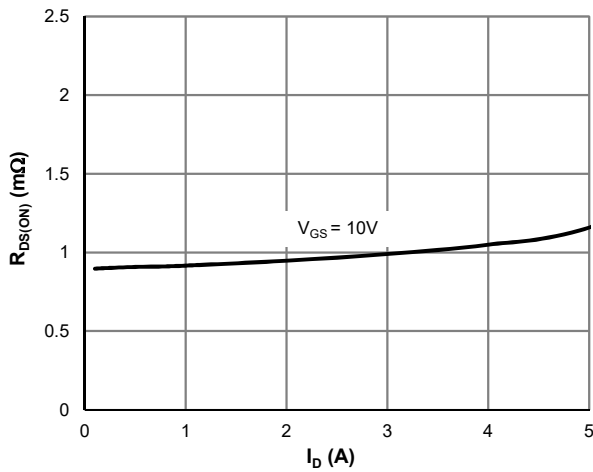
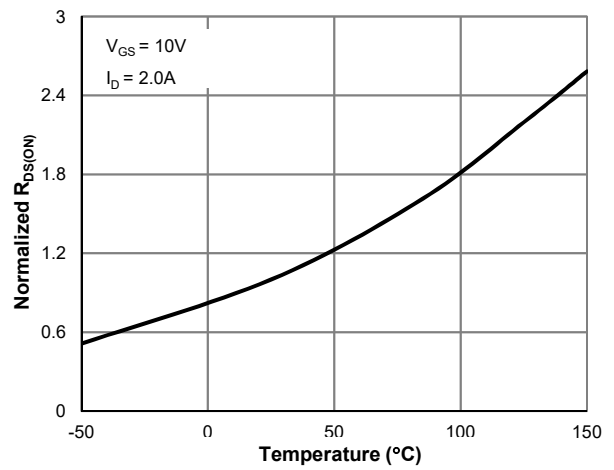
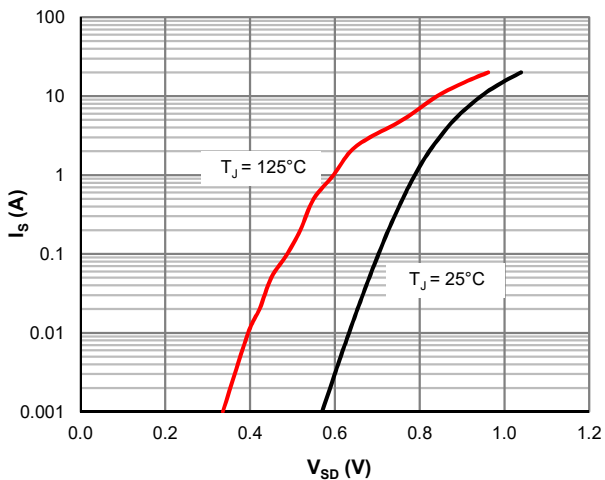
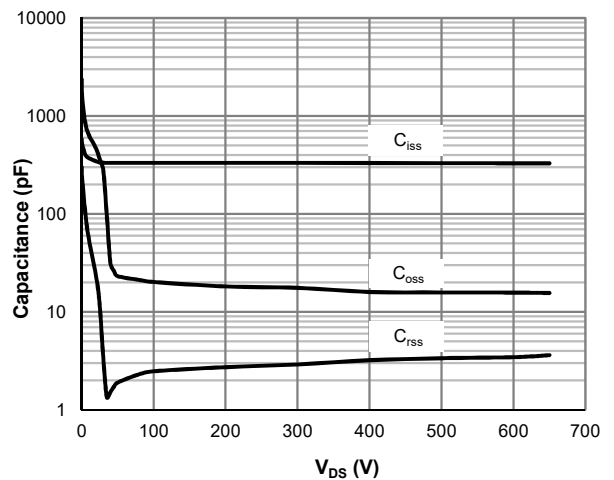
Typical Electrical & Thermal Characteristics

Figure 1: Saturation Characteristics

Figure 2: Transfer Characteristics

Figure 3: $R_{DS(ON)}$ vs. Drain Current

Figure 4: $R_{DS(ON)}$ vs. Junction Temperature

Figure 5: Body-Diode Characteristics

Figure 6: Capacitance Characteristics



Typical Electrical & Thermal Characteristics

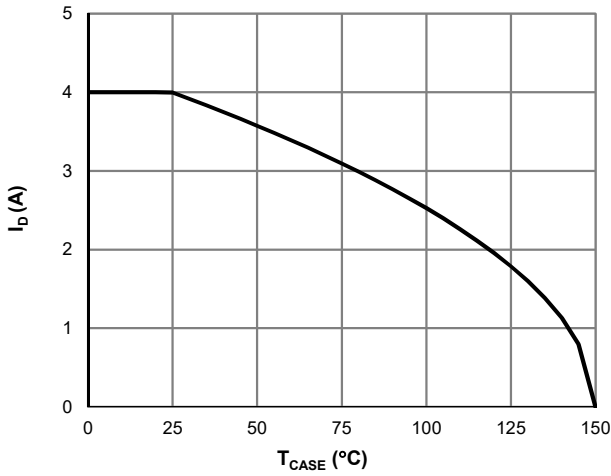

Figure 7: Current De-rating

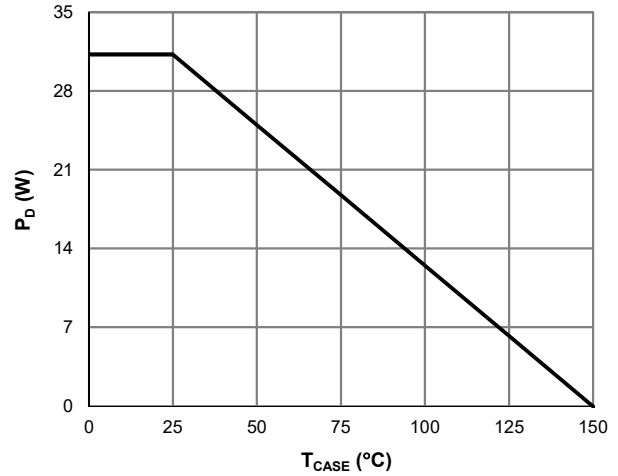

Figure 8: Power De-rating

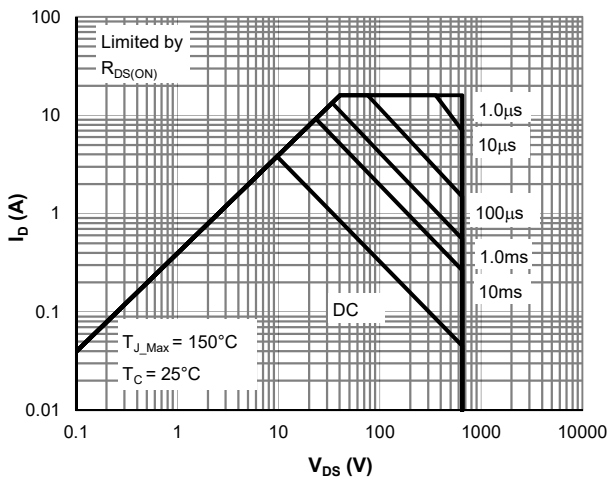

Figure 9: Maximum Safe Operating Area

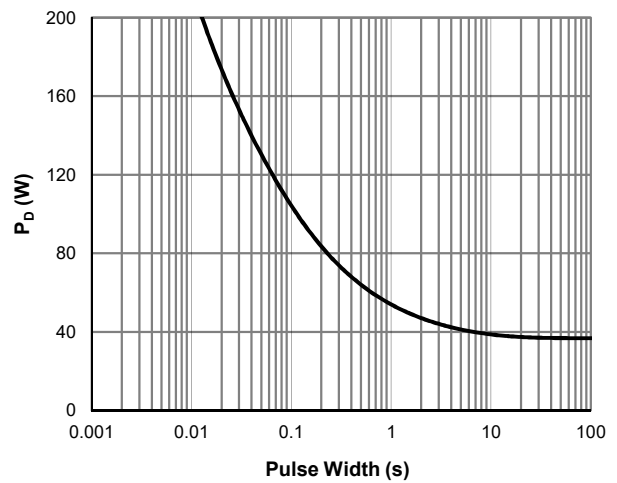

Figure 10: Single Pulse Power Rating, Junction-to-Case

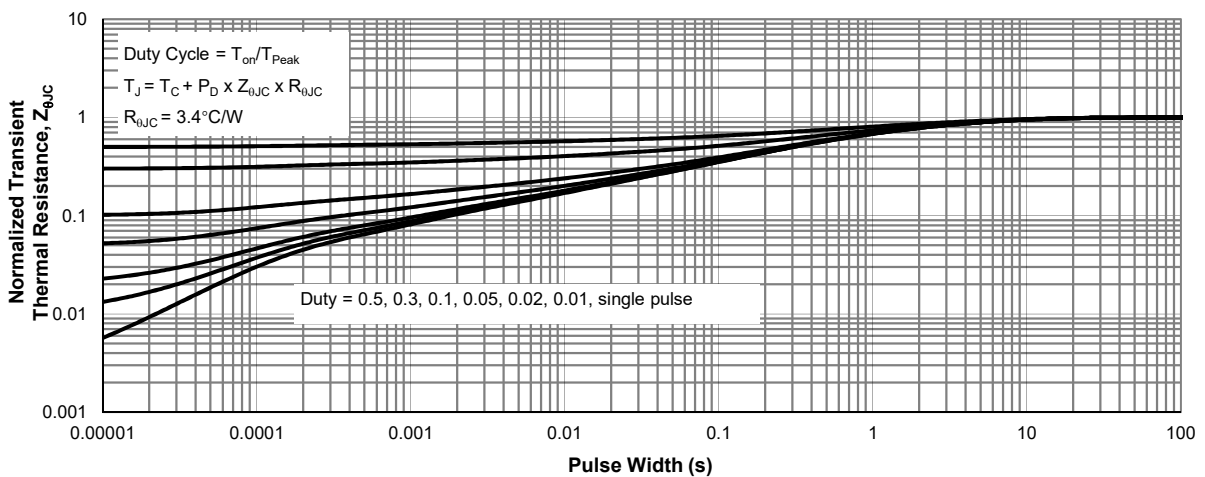
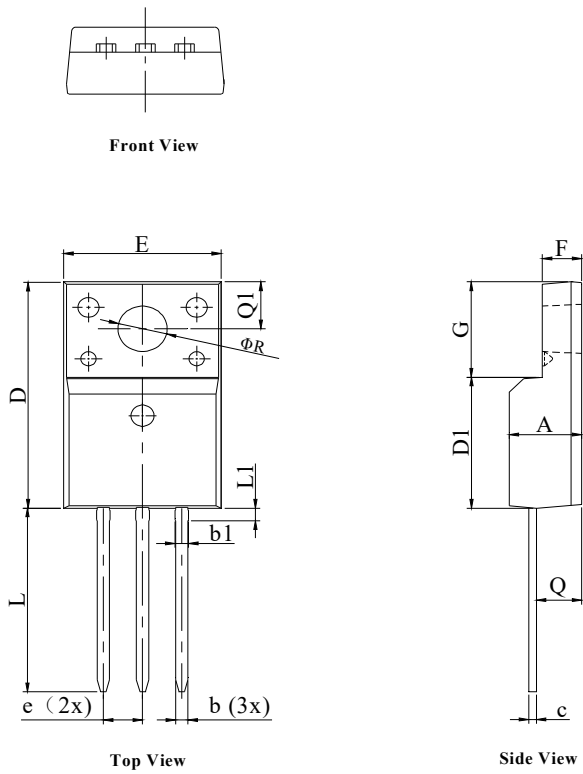

Figure 11: Normalized Maximum Transient Thermal Impedance

TO-220FP-NL Package Information
Package Outline

DIM.	MILLIMETER		
	MIN.	NOM.	MAX.
A	4.30	4.50	4.70
D	14.70	15.00	15.30
D1	8.50 REF		
E	9.70	10.00	10.30
F	2.50	2.70	2.90
b	0.60	0.70	0.80
b1	0.60	0.80	0.90
c	0.45	0.50	0.60
e	2.60 BSC		
G	6.30	6.50	6.70
L	13.40	13.60	13.80
L1	1.00	1.10	1.20
Q	2.50	2.60	2.70
Q1	2.90	3.00	3.10
R	3.50 REF		