



100V 111mΩ Dual N-Ch Power MOSFET

Features

- Low Gate Charge
- 100% UIS Tested, 100% R_g Tested
- Pb-free Lead Plating
- Halogen-free and RoHS-compliant

Applications

- Power Management in Telecom., Industrial Automation, CE
- Current Switching in DC/DC & AC/DC Sub-systems

Product Summary

Parameter	Value	Unit
V _{DS}	100	V
V _{GS(th)_Typ}	1.7	V
I _D (@ V _{GS} = 10V) ⁽¹⁾	2.4	A
R _{DS(ON)_Typ} (@ V _{GS} = 10V)	111	mΩ
R _{DS(ON)_Typ} (@ V _{GS} = 4.5V)	155	mΩ

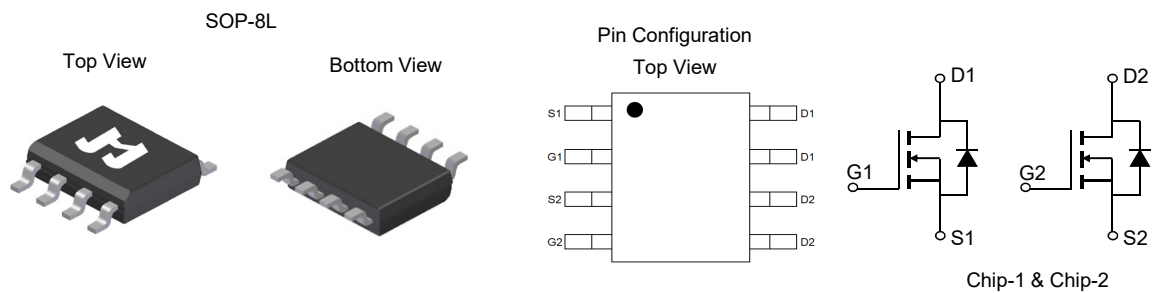

Ordering Information

Device	Package	# of Pins	Marking	MSL	T _J (°C)	Media	Quantity (pcs)
JMSL10130APD-13	SOP-8L	8	L10130AD	3	-55 to 150	13-inch Reel	2500

Absolute Maximum Ratings (@ T_A = 25°C unless otherwise specified)

Parameter	Symbol	Value	Unit
Drain-to-Source Voltage	V _{DS}	100	V
Gate-to-Source Voltage	V _{GS}	±20	V
Continuous Drain Current ⁽¹⁾	I _D	T _A = 25°C	2.4
		T _A = 70°C	1.9
Pulsed Drain Current ⁽²⁾	I _{DM}	9.5	A
Avalanche Current ⁽³⁾	I _{AS}	4.3	A
Avalanche Energy ⁽³⁾	E _{AS}	0.92	mJ
Power Dissipation ⁽⁴⁾	P _D	T _A = 25°C	2.5
		T _A = 70°C	1.6
Junction & Storage Temperature Range	T _J , T _{STG}	-55 to 150	°C

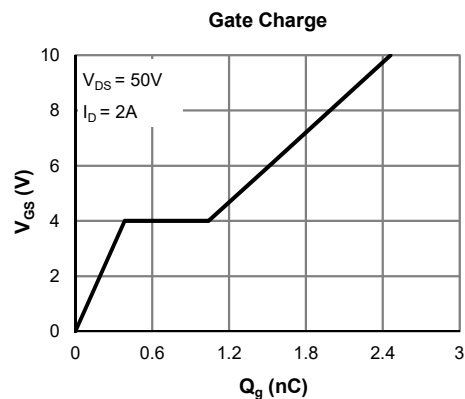
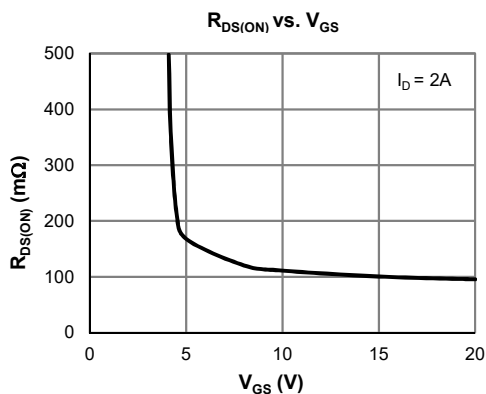



Electrical Characteristics (@ $T_J = 25^\circ\text{C}$ unless otherwise specified)

Parameter	Symbol	Conditions	Min.	Typ.	Max.	Unit
STATIC PARAMETERS						
Drain-Source Breakdown Voltage	$V_{(BR)DSS}$	$I_D = 250\mu\text{A}, V_{GS} = 0\text{V}$	100			V
Zero Gate Voltage Drain Current	I_{DSS}	$V_{DS} = 80\text{V}, V_{GS} = 0\text{V}$			1.0	μA
					5.0	
Gate-Body Leakage Current	I_{GSS}	$V_{DS} = 0\text{V}, V_{GS} = \pm 20\text{V}$			± 100	nA
Gate Threshold Voltage	$V_{GS(th)}$	$V_{DS} = V_{GS}, I_D = 250\mu\text{A}$	1.2	1.7	2.5	V
Static Drain-Source ON-Resistance	$R_{DS(on)}$	$V_{GS} = 10\text{V}, I_D = 2\text{A}$		111	139	$\text{m}\Omega$
	$R_{DS(on)}$	$V_{GS} = 4.5\text{V}, I_D = 1\text{A}$		155	195	$\text{m}\Omega$
Forward Transconductance	g_{FS}	$V_{DS} = 5\text{V}, I_D = 2\text{A}$		4.5		S
Diode Forward Voltage	V_{SD}	$I_S = 1\text{A}, V_{GS} = 0\text{V}$		0.70	1.0	V
Diode Continuous Current	I_S	$T_A = 25^\circ\text{C}$			2.5	A
DYNAMIC PARAMETERS ⁽⁵⁾						
Input Capacitance	C_{iss}	$V_{GS} = 0\text{V}, V_{DS} = 50\text{V}, f = 1\text{MHz}$		103		pF
Output Capacitance	C_{oss}			47		pF
Reverse Transfer Capacitance	C_{rss}			4.9		pF
Gate Resistance	R_g	$V_{GS} = 0\text{V}, V_{DS} = 0\text{V}, f = 1\text{MHz}$		2.6		Ω
SWITCHING PARAMETERS ⁽⁵⁾						
Total Gate Charge (@ $V_{GS} = 10\text{V}$)	Q_g	$V_{GS} = 0 \text{ to } 10\text{V}$ $V_{DS} = 50\text{V}, I_D = 2\text{A}$		2.5		nC
Total Gate Charge (@ $V_{GS} = 4.5\text{V}$)	Q_g			1.3		nC
Gate Source Charge	Q_{gs}			0.30		nC
Gate Drain Charge	Q_{gd}			0.70		nC
Turn-On Delay Time	$t_{D(on)}$	$V_{GS} = 10\text{V}, V_{DS} = 50\text{V}$ $R_L = 25\Omega, R_{GEN} = 6\Omega$		2.1		ns
Turn-On Rise Time	t_r			3.3		ns
Turn-Off Delay Time	$t_{D(off)}$			7.5		ns
Turn-Off Fall Time	t_f			3.2		ns
Body Diode Reverse Recovery Time	t_{rr}	$I_F = 2\text{A}, dI_F/dt = 100\text{A}/\mu\text{s}$		21		ns
Body Diode Reverse Recovery Charge	Q_{rr}	$I_F = 2\text{A}, dI_F/dt = 100\text{A}/\mu\text{s}$		8.0		nC

Thermal Performance

Parameter	Symbol	Typ.	Max.	Unit
Thermal Resistance, Junction-to-Ambient ($t \leq 10\text{s}$)	$R_{\theta JA}$	40	50	$^\circ\text{C}/\text{W}$
Thermal Resistance, Junction-to-Ambient (steady state)	$R_{\theta JA}$	70	85	$^\circ\text{C}/\text{W}$

Notes:

1. Computed continuous current assumes the condition of T_{J_Max} while the actual continuous current depends on the thermal & electro-mechanical application board design.
2. This single-pulse measurement was taken under $T_{J_Max} = 150^\circ\text{C}$.
3. This single-pulse measurement was taken under the following condition [$L = 100\mu\text{H}, V_{GS} = 10\text{V}, V_{DS} = 50\text{V}$] while its value is limited by $T_{J_Max} = 150^\circ\text{C}$.
4. The power dissipation P_D is based on $T_{J_Max} = 150^\circ\text{C}$.
5. This value is guaranteed by design hence it is not included in the production test.

Typical Electrical & Thermal Characteristics

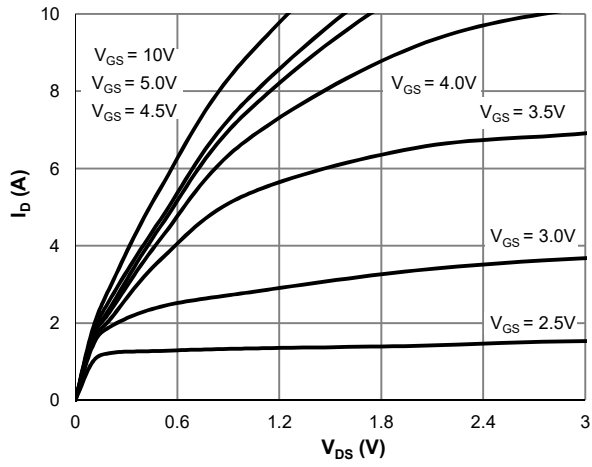

Figure 1: Saturation Characteristics

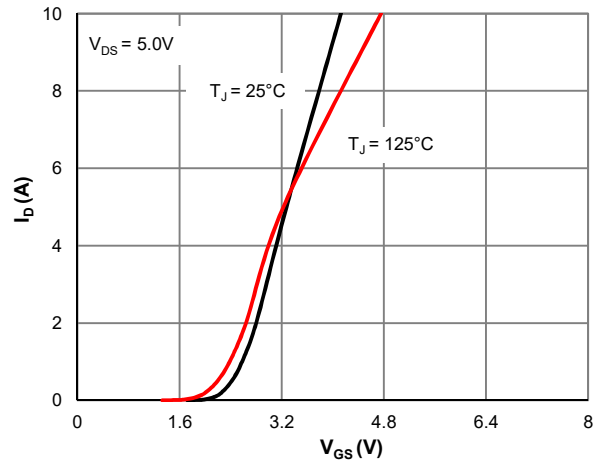

Figure 2: Transfer Characteristics

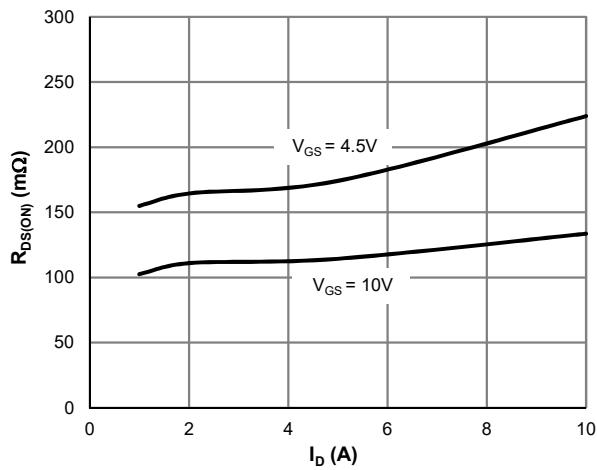

Figure 3: $R_{DS(ON)}$ vs. Drain Current

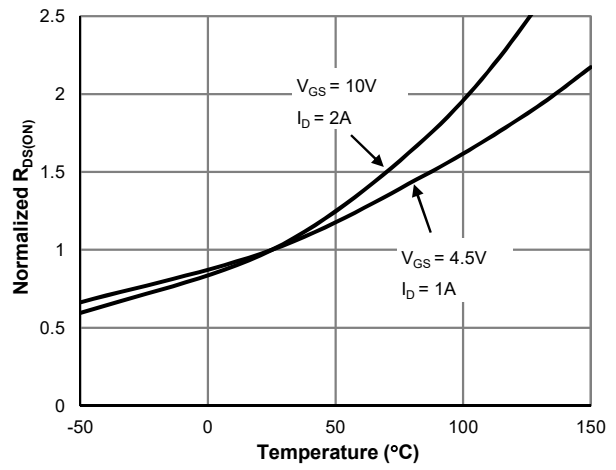

Figure 4: $R_{DS(ON)}$ vs. Junction Temperature

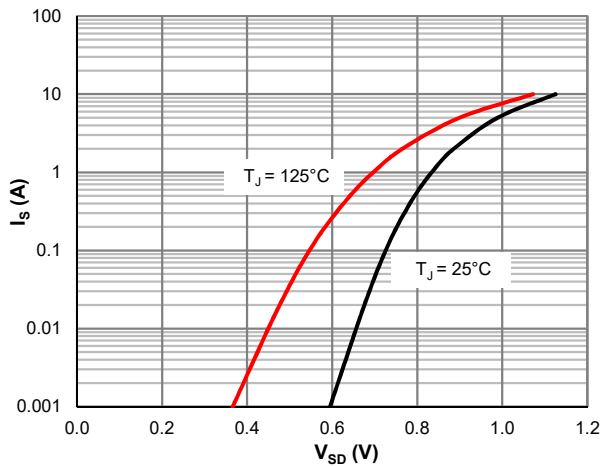

Figure 5: Body-Diode Characteristics

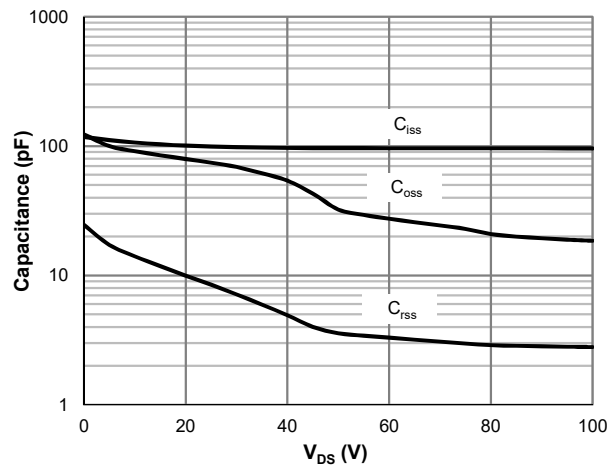

Figure 6: Capacitance Characteristics

Typical Electrical & Thermal Characteristics

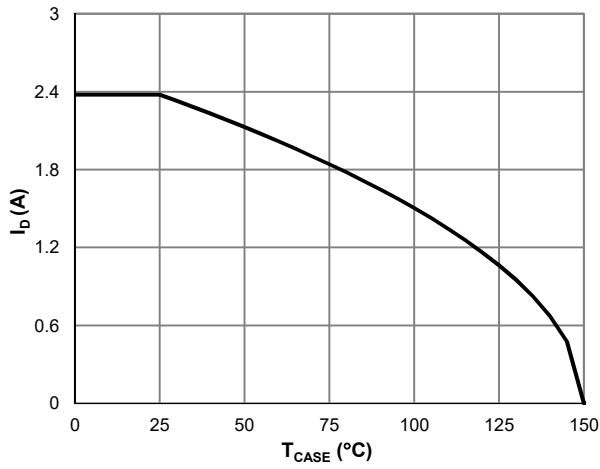

Figure 7: Current De-rating

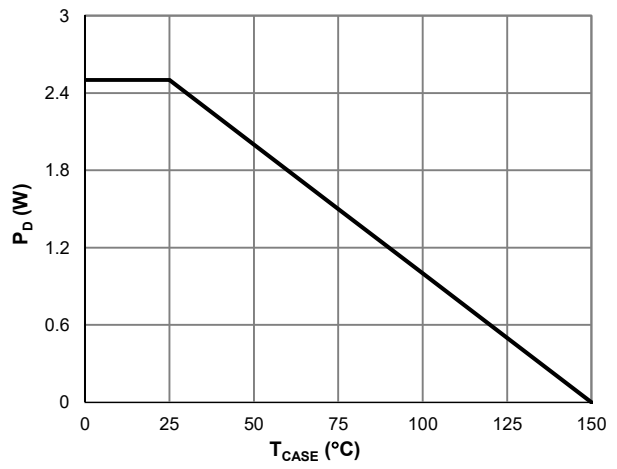

Figure 8: Power De-rating

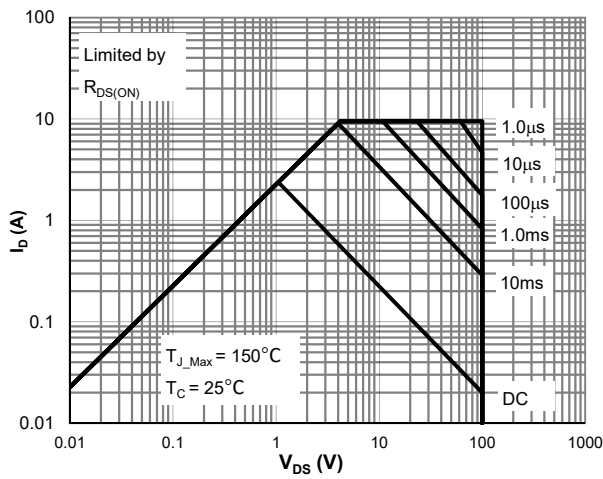

Figure 9: Maximum Safe Operating Area

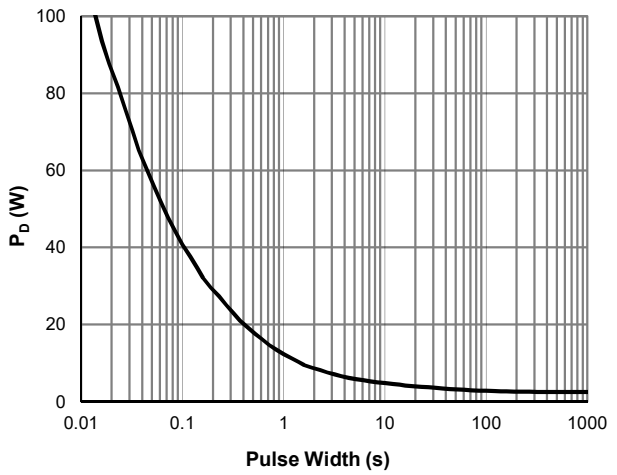

Figure 10: Single Pulse Power Rating, Junction-to-Case

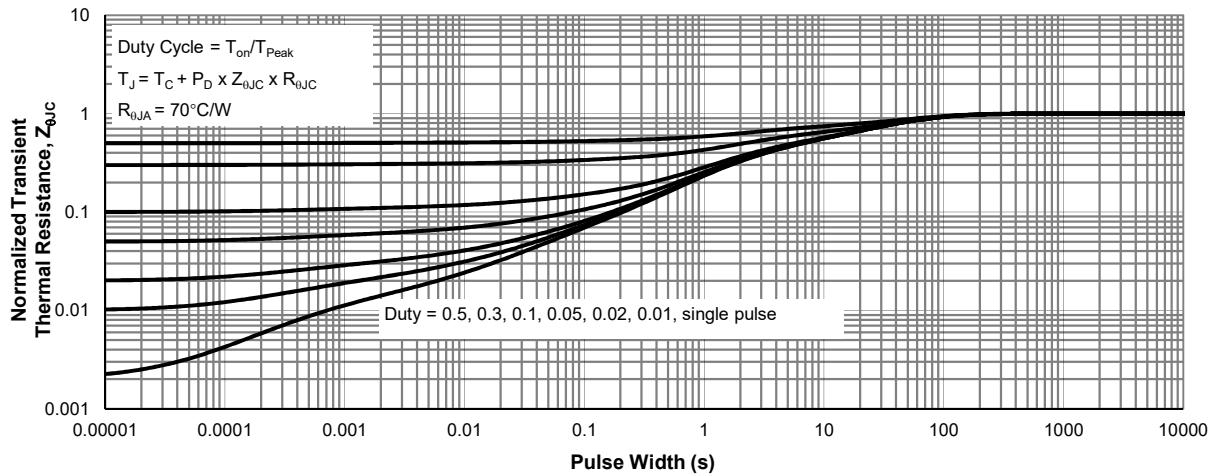
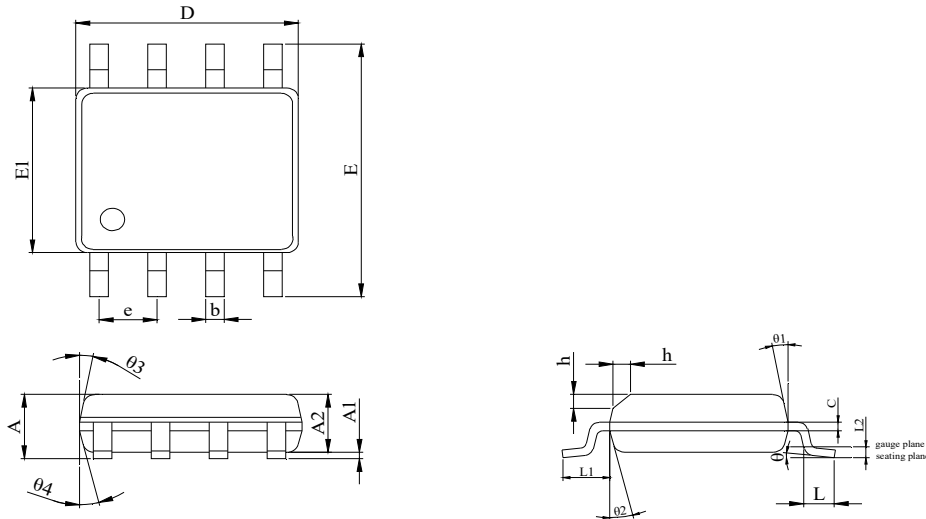

Figure 11: Normalized Maximum Transient Thermal Impedance

SOP-8L Package Information

Package Outline



DIM	MILLIMETER		
	MIN.	NOM.	MAX.
A	1.35	1.50	1.65
A1	0.05	0.10	0.15
A2	1.35	1.40	1.50
b	0.38	--	0.50
c	0.17	--	0.25
D	4.80	4.90	5.00
E	5.80	6.00	6.20
E1	3.80	3.90	4.00
e	1.27(BSC)		
L	0.45	0.60	0.80
L1	1.04 REF		
L2	0.25 BSC		
h	0.30	0.40	0.50
θ	0°	--	8°
θ_1	10°	12°	14°
θ_2	8°	10°	12°
θ_3	10°	12°	14°
θ_4	8°	10°	12°

Recommended Footprint

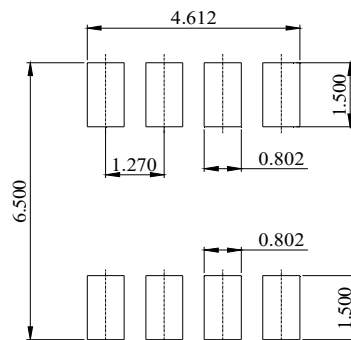

DIMENSIONS: MILLIMETERS