

100V 32mΩ N-Ch Power MOSFET

Features

- Low Gate Charge
- 100% UIS Tested, 100% R_g Tested
- Pb-free Lead Plating
- Halogen-free and RoHS-compliant

Product Summary

| Parameter | Value | Unit |
|---|-------|------|
| V _{DS} | 100 | V |
| V _{GS(th)_Typ} | 2.0 | V |
| I _D (@ V _{GS} = 10V) ⁽¹⁾ | 24 | A |
| R _{DS(ON)_typ} (@ V _{GS} = 10V) | 32 | mΩ |
| R _{DS(ON)_typ} (@ V _{GS} = 4.5V) | 43 | mΩ |

Applications

- Power Management in Telecom., Industrial Automation, CE
- Current Switching in DC/DC & AC/DC (SR) Sub-systems
- Motor Driving in Power Tool, E-vehicle, Robotics

TO-252-3L Top View

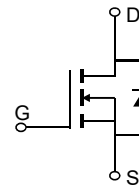
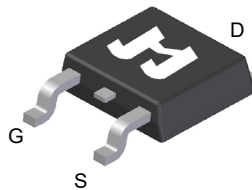
Ordering Information

| Device | Package | # of Pins | Marking | MSL | T _J (°C) | Media | Quantity (pcs) |
|---------------|-----------|-----------|---------|-----|---------------------|--------------|----------------|
| JMSL1040AK-13 | TO-252-3L | 3 | SL1040A | 1 | -55 to 150 | 13-inch Reel | 2500 |

Absolute Maximum Ratings (@ T_A = 25°C unless otherwise specified)

| Parameter | Symbol | Value | Unit |
|---|-----------------------------------|------------------------|------|
| Drain-to-Source Voltage | V _{DS} | 100 | V |
| Gate-to-Source Voltage | V _{GS} | ±20 | V |
| Continuous Drain Current ⁽¹⁾ | I _D | T _C = 25°C | 24 |
| | | T _C = 100°C | 15 |
| Pulsed Drain Current ⁽²⁾ | I _{DM} | 66 | A |
| Avalanche Current ⁽³⁾ | I _{AS} | 14 | A |
| Avalanche Energy ⁽³⁾ | E _{AS} | 10 | mJ |
| Power Dissipation ⁽⁴⁾ | P _D | T _C = 25°C | 43 |
| | | T _C = 100°C | 17 |
| Junction & Storage Temperature Range | T _J , T _{STG} | -55 to 150 | °C |

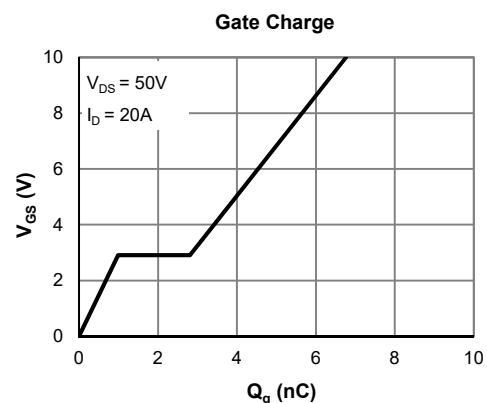
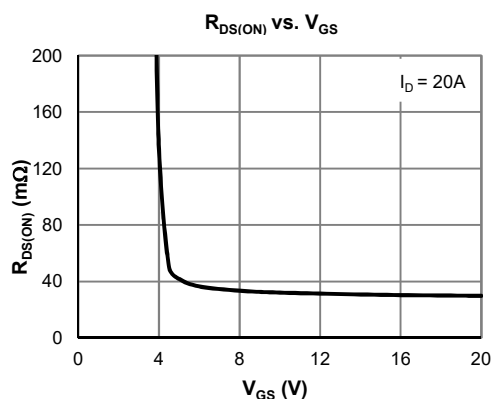



Electrical Characteristics (@ $T_J = 25^\circ\text{C}$ unless otherwise specified)

| Parameter | Symbol | Conditions | Min. | Typ. | Max. | Unit |
|---|---------------|--|---|------|-----------|---------------|
| STATIC PARAMETERS | | | | | | |
| Drain-Source Breakdown Voltage | $V_{(BR)DSS}$ | $I_D = 250\mu\text{A}, V_{GS} = 0\text{V}$ | 100 | | | V |
| Zero Gate Voltage Drain Current | I_{DSS} | $V_{DS} = 80\text{V}, V_{GS} = 0\text{V}$ | | | 1.0 | μA |
| | | | | | 5.0 | |
| Gate-Body Leakage Current | I_{GSS} | $V_{DS} = 0\text{V}, V_{GS} = \pm 20\text{V}$ | | | ± 100 | nA |
| Gate Threshold Voltage | $V_{GS(th)}$ | $V_{DS} = V_{GS}, I_D = 250\mu\text{A}$ | 1.2 | 2.0 | 2.5 | V |
| Static Drain-Source ON-Resistance | $R_{DS(ON)}$ | $V_{GS} = 10\text{V}, I_D = 20\text{A}$ | | 32 | 39 | m Ω |
| Static Drain-Source ON-Resistance | $R_{DS(ON)}$ | $V_{GS} = 4.5\text{V}, I_D = 15\text{A}$ | | 43 | 54 | m Ω |
| Forward Transconductance | g_{FS} | $V_{DS} = 5\text{V}, I_D = 20\text{A}$ | | 28 | | S |
| Diode Forward Voltage | V_{SD} | $I_S = 1\text{A}, V_{GS} = 0\text{V}$ | | 0.71 | 1.0 | V |
| Diode Continuous Current | I_S | $T_C = 25^\circ\text{C}$ | | | 43 | A |
| DYNAMIC PARAMETERS ⁽⁵⁾ | | | | | | |
| Input Capacitance | C_{iss} | $V_{GS} = 0\text{V}, V_{DS} = 50\text{V}, f = 1\text{MHz}$ | | 363 | | pF |
| Output Capacitance | C_{oss} | | | 85 | | pF |
| Reverse Transfer Capacitance | C_{rss} | | | 3.0 | | pF |
| Gate Resistance | R_g | $V_{GS} = 0\text{V}, V_{DS} = 0\text{V}, f = 1\text{MHz}$ | | 1.7 | | Ω |
| SWITCHING PARAMETERS ⁽⁵⁾ | | | | | | |
| Total Gate Charge (@ $V_{GS} = 10\text{V}$) | Q_g | $V_{GS} = 0 \text{ to } 10\text{V}$ $V_{DS} = 50\text{V}, I_D = 20\text{A}$ | | 6.8 | | nC |
| Total Gate Charge (@ $V_{GS} = 4.5\text{V}$) | Q_g | | | 3.7 | | nC |
| Gate Source Charge | Q_{gs} | | | 1.0 | | nC |
| Gate Drain Charge | Q_{gd} | | | 1.8 | | nC |
| Turn-On Delay Time | $t_{D(on)}$ | $V_{GS} = 10\text{V}, V_{DS} = 50\text{V}$ $R_L = 2.5\Omega, R_{GEN} = 6\Omega$ | | 4.9 | | ns |
| Turn-On Rise Time | t_r | | | 16.6 | | ns |
| Turn-Off Delay Time | $t_{D(off)}$ | | | 11.2 | | ns |
| Turn-Off Fall Time | t_f | | | 4.9 | | ns |
| Body Diode Reverse Recovery Time | t_{rr} | | $I_F = 15\text{A}, dI_F/dt = 100\text{A}/\mu\text{s}$ | | 33 | |
| Body Diode Reverse Recovery Charge | Q_{rr} | $I_F = 15\text{A}, dI_F/dt = 100\text{A}/\mu\text{s}$ | | 45 | | nC |

Thermal Performance

| Parameter | Symbol | Typ. | Max. | Unit |
|---|-----------------|------|------|---------------------------|
| Thermal Resistance, Junction-to-Ambient | $R_{\theta JA}$ | 50 | 60 | $^\circ\text{C}/\text{W}$ |
| Thermal Resistance, Junction-to-Case | $R_{\theta JC}$ | 2.2 | 2.9 | $^\circ\text{C}/\text{W}$ |

Notes:

1. Computed continuous current assumes the condition of T_{J_Max} while the actual continuous current depends on the thermal & electro-mechanical application board design.
2. This single-pulse measurement was taken under $T_{J_Max} = 150^\circ\text{C}$.
3. This single-pulse measurement was taken under the following condition [$L = 100\mu\text{H}, V_{GS} = 10\text{V}, V_{DS} = 50\text{V}$] while its value is limited by $T_{J_Max} = 150^\circ\text{C}$.
4. The power dissipation P_D is based on $T_{J_Max} = 150^\circ\text{C}$.
5. This value is guaranteed by design hence it is not included in the production test.

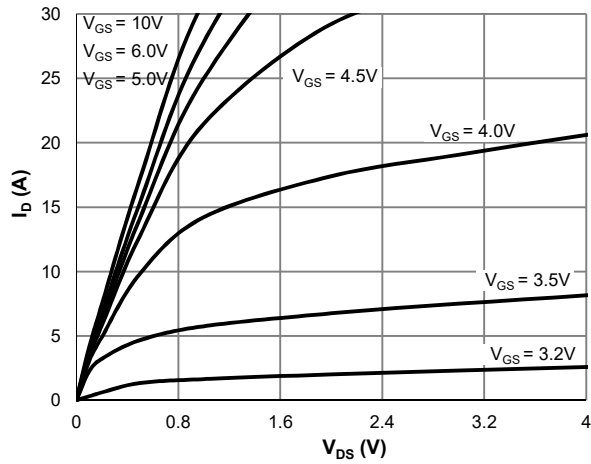
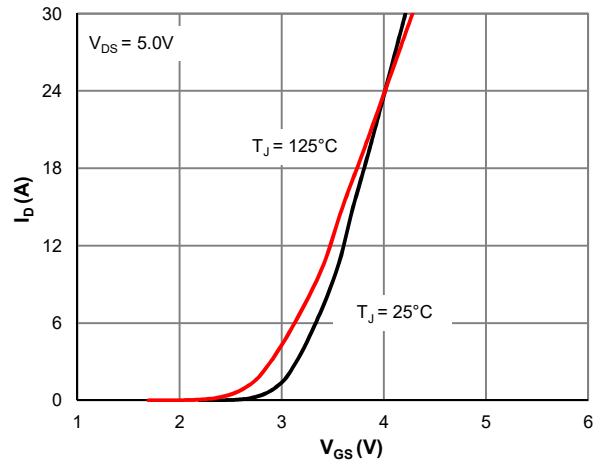
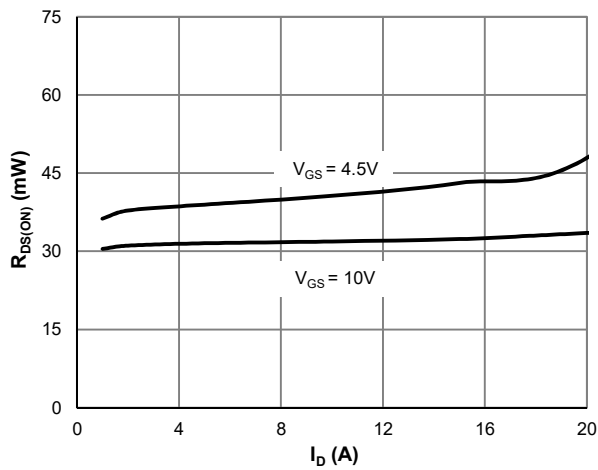
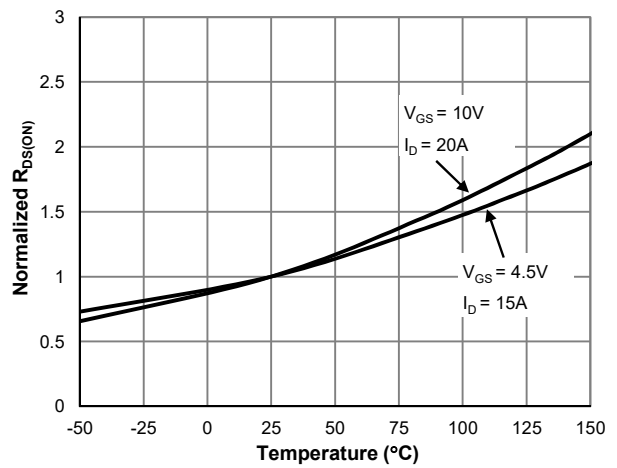
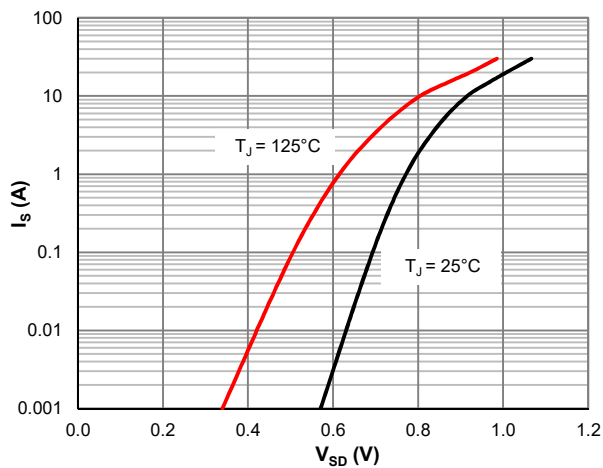
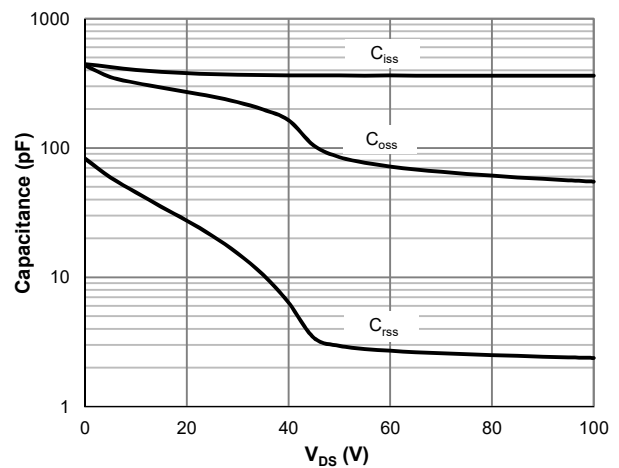
Typical Electrical & Thermal Characteristics

Figure 1: Saturation Characteristics

Figure 2: Transfer Characteristics

Figure 3: $R_{DS(ON)}$ vs. Drain Current

Figure 4: $R_{DS(ON)}$ vs. Junction Temperature

Figure 5: Body-Diode Characteristics

Figure 6: Capacitance Characteristics

Typical Electrical & Thermal Characteristics

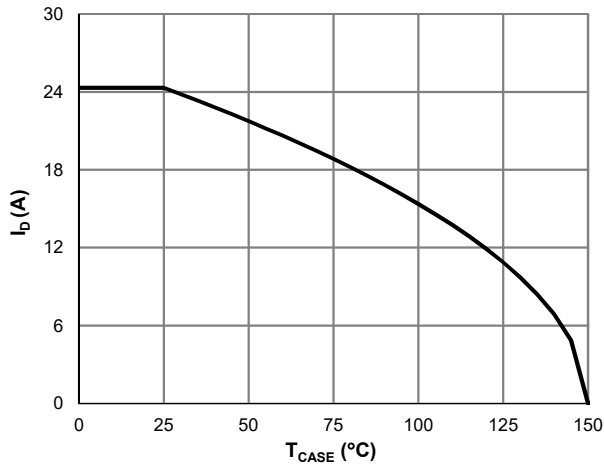

Figure 7: Current De-rating

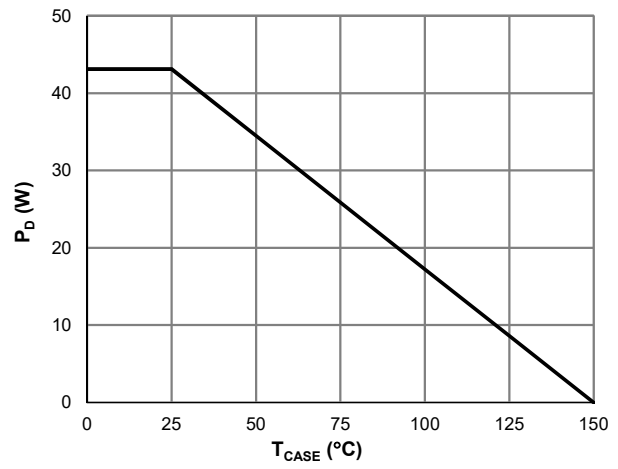

Figure 8: Power De-rating

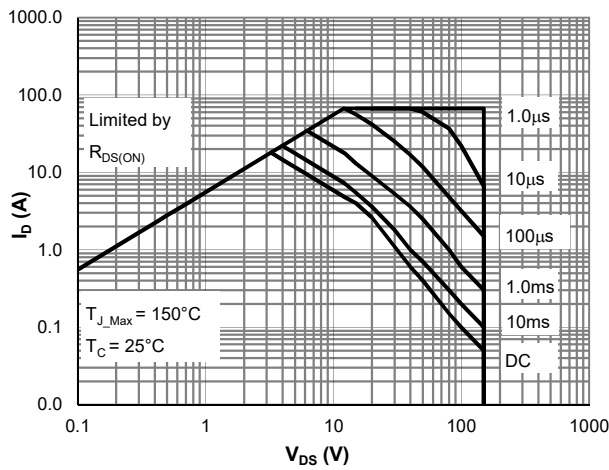

Figure 9: Maximum Safe Operating Area

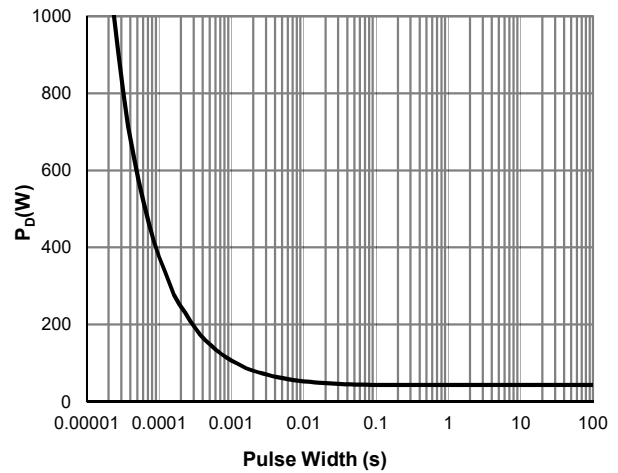

Figure 10: Single Pulse Power Rating, Junction-to-Case

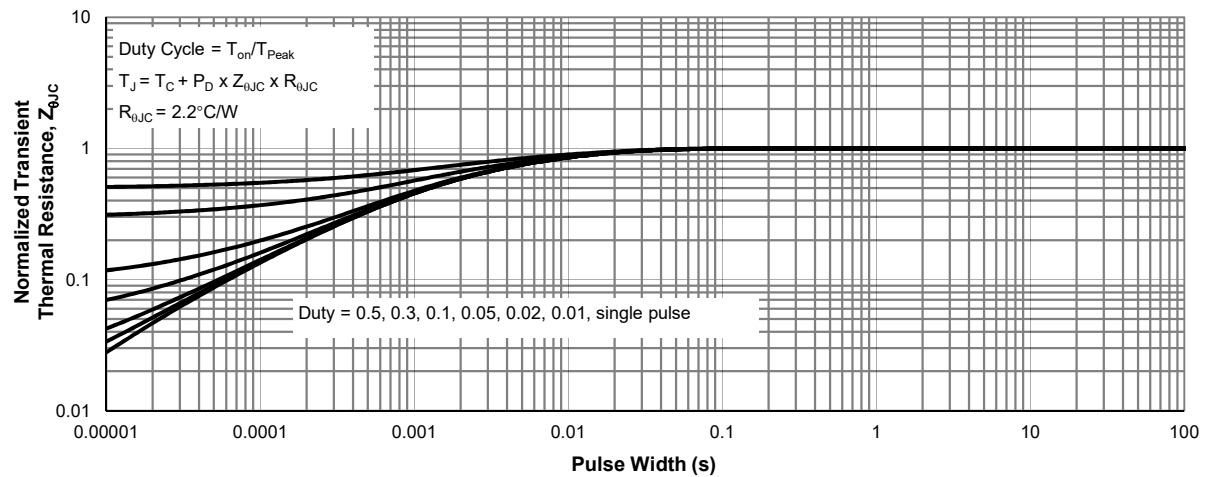
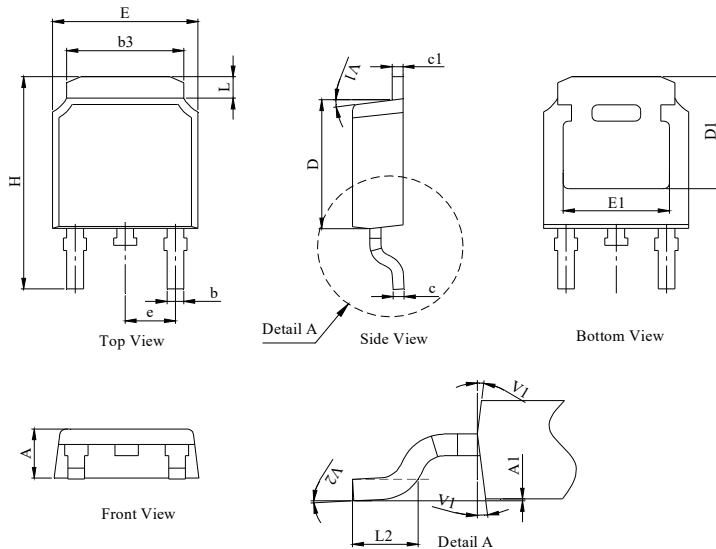
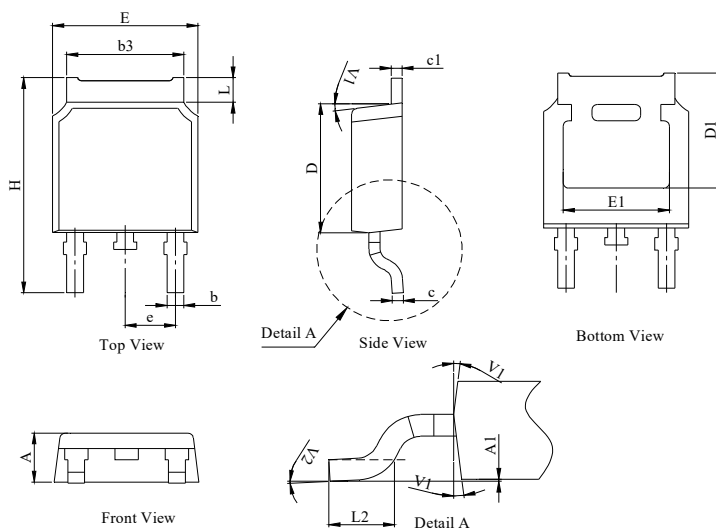

Figure 11: Normalized Maximum Transient Thermal Impedance

TO-252-3L Package Information
Package Outline Type-A

| DIM. | MILLIMETER | | |
|------|------------|-------|-------|
| | MIN. | NOM. | MAX. |
| A | 2.18 | 2.30 | 2.39 |
| A1 | 0 | -- | 0.13 |
| b | 0.64 | 0.76 | 0.89 |
| c | 0.40 | 0.50 | 0.61 |
| c1 | 0.46 | 0.50 | 0.58 |
| D | 5.97 | 6.10 | 6.23 |
| D1 | 5.05 | -- | -- |
| E | 6.35 | 6.60 | 6.73 |
| E1 | 4.32 | -- | -- |
| b3 | 5.21 | 5.38 | 5.55 |
| e | 2.29 BSC | | |
| H | 9.40 | 10.00 | 10.40 |
| L | 0.89 | -- | 1.27 |
| L2 | 1.40 | -- | 1.78 |
| V1 | 7° REF | | |
| V2 | 0° | -- | 6° |

Package Outline Type-B

| DIM. | MILLIMETER | | |
|------|------------|-------|-------|
| | MIN. | NOM. | MAX. |
| A | 2.10 | 2.30 | 2.40 |
| A1 | 0 | -- | 0.13 |
| b | 0.66 | 0.76 | 0.86 |
| b3 | 5.21 | 5.38 | 5.55 |
| c | 0.40 | 0.50 | 0.60 |
| c1 | 0.44 | 0.50 | 0.58 |
| D | 5.90 | 6.10 | 6.30 |
| D1 | 5.30REF | | |
| E | 6.40 | 6.60 | 6.80 |
| E1 | 4.63 | - | - |
| e | 2.29 BSC | | |
| H | 9.50 | 10.00 | 10.70 |
| L | 1.09 | -- | 1.21 |
| L2 | 1.35 | -- | 1.65 |
| V1 | 7° REF | | |
| V2 | 0° | -- | 6° |

Recommended Soldering Footprint
