



## JOC3H4X Series

### SSOP4, AC Input, Photo Transistor Coupler

#### Description

The JOC3H4X series combine two AlGaAs infrared emitting diodes as the emitter which is optically coupled to a silicon planar phototransistor detector in a plastic SSOP4 package

With the robust coplanar double mold structure, JOC3H4X series provide the most stable isolation feature.

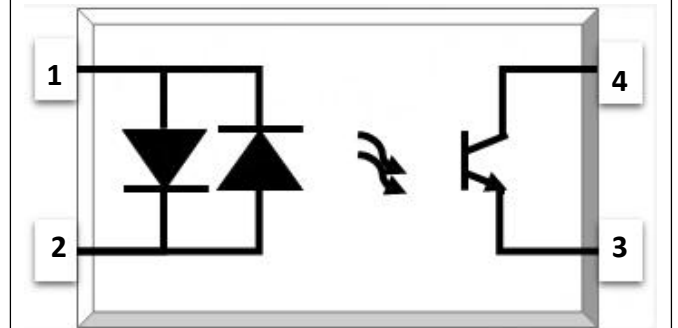
#### Features

- High isolation 3750 VRMS
- CTR flexibility available see order information
- AC input with transistor output
- Operating temperature range - 55 °C to 110 °C
- REACH compliance
- Halogen free
- MSL class 1

#### Applications

- Switch mode power supplies
- Programmable controllers
- Household appliances
- Office equipment

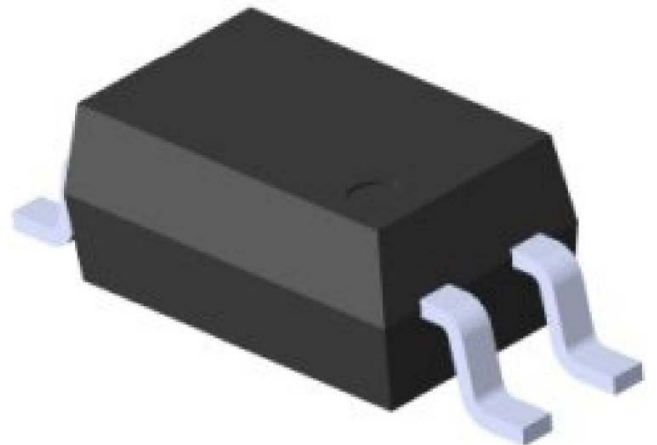
#### SCHEMATIC



#### PIN DEFINITION

1. Anode/ Cathode
2. Cathode/Anode
3. Emitter
4. Collector

#### PACKAGE OUTLINE



**ABSOLUTE MAXIMUM RATINGS**

PARAMETER	SYMBOL	VALUE	UNIT	NOTE
<b>INPUT</b>				
Forward Current	$I_F$	$\pm 60$	mA	
Peak Forward Current	$I_{FP}$	$\pm 1$	A	1
Input Power Dissipation	$P_I$	100	mW	
<b>OUTPUT</b>				
Collector - Emitter Voltage	$V_{CEO}$	80	V	
Emitter - Collector Voltage	$V_{ECO}$	6	V	
Collector Current	$I_C$	50	mA	
Output Power Dissipation	$P_O$	150	mW	
<b>COMMON</b>				
Total Power Dissipation	$P_{tot}$	200	mW	
Isolation Voltage	$V_{iso}$	3750	V <sub>rms</sub>	2
Operating Temperature	$T_{opr}$	-55~110	°C	
Storage Temperature	$T_{stg}$	-55~125	°C	
Soldering Temperature	$T_{sol}$	260	°C	

Note 1. 100 $\mu$ s pulse, 100Hz frequency

Note 2. AC For 1 Minute, R.H. = 40 ~ 60%

**ELECTRICAL OPTICAL CHARACTERISTICS at Ta=25°C**

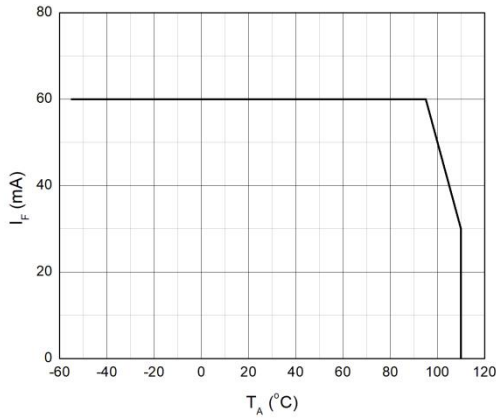
PARAMETER	SYMBOL	MIN	TYP.	MAX.	UNIT	TEST CONDITION	NOTE
INPUT							
Forward Voltage	$V_F$	-	-	1.4	V	$I_F=10\text{mA}$	
Input Capacitance	$C_{in}$	-	10	-	pF	$V=0, f=1\text{kHz}$	
OUTPUT							
Collector Dark Current	$I_{CEO}$	-	-	100	nA	$V_{CE}=20\text{V}, I_F=0$	
Collector-Emitter Breakdown Voltage	$BV_{CEO}$	80	-	-	V	$I_C=0.1\text{mA}, I_F=0$	
Emitter-Collector Breakdown Voltage	$BV_{ECO}$	6	-	-	V	$I_E=0.1\text{mA}, I_F=0$	
TRANSFER CHARACTERISTICS							
Current Transfer Ratio	JOC3H4	20	-	300	%	$I_F=1\text{mA}, V_{CE}=5\text{V}$	
	JOC3H4A	50	-	150			
	JOC3H4B	100	-	300			
CTR Symmetry		0.7	-	1.3		$I_F=\pm 1\text{mA}, V_{CE}=5\text{V}$	
Collector-Emitter Saturation Voltage	$V_{CE(sat)}$	-	0.07	0.2	V	$I_F=20\text{mA}, I_C=1\text{mA}$	
Isolation Resistance	$R_{ISO}$	$10^{12}$	$10^{14}$	-	$\Omega$	DC500V, 40 ~ 60% R.H.	
Floating Capacitance	$C_{IO}$	-	0.4	1	pF	$V=0, f=1\text{MHz}$	
Response Time (Rise)	$t_r$	-	7	18	$\mu\text{s}$	$V_{CE}=2\text{V}, I_C=2\text{mA}$	3
Response Time (Fall)	$t_f$	-	9	18	$\mu\text{s}$	$R_L=100\Omega$	3

Note 3. Fig.12&amp;13

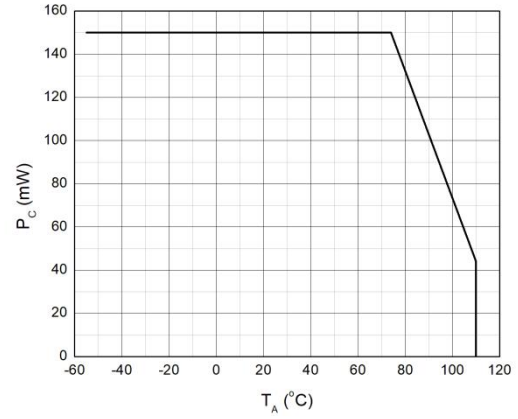
Note 4. Fig.14

**CHARACTERISTIC CURVES**

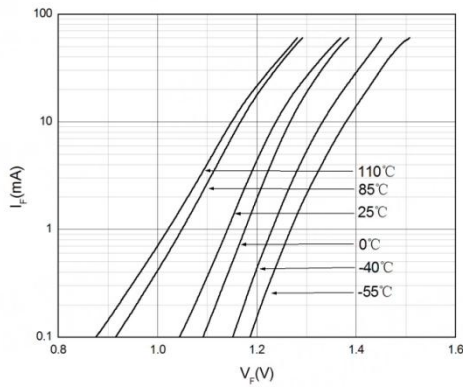
**Fig.1 Forward Current vs. Ambient Temperature**



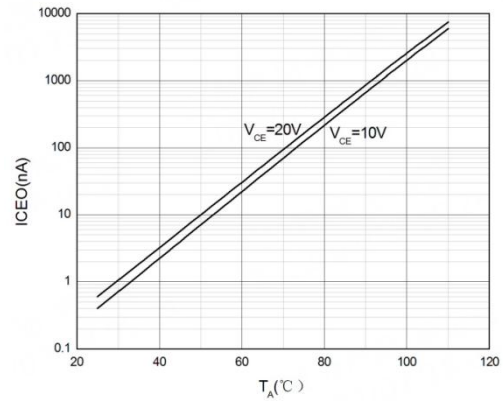
**Fig.2 Collector Power Dissipation vs. Ambient Temperature**



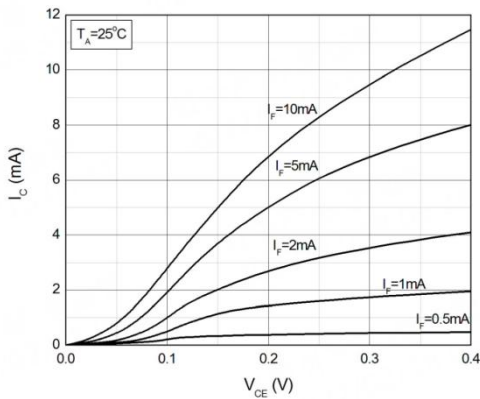
**Fig.3 Forward Current vs. Forward Voltage**



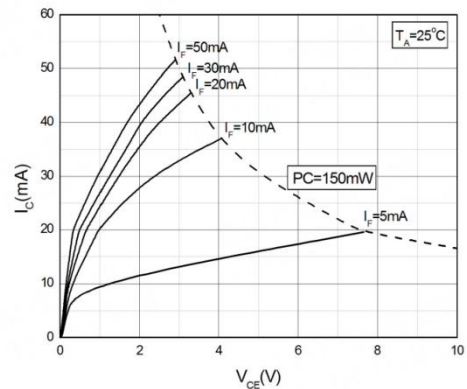
**Fig.4 Collector Dark Current vs. Ambient Temperature**



**Fig.5 Collector Current vs. Collector-emitter Voltage**

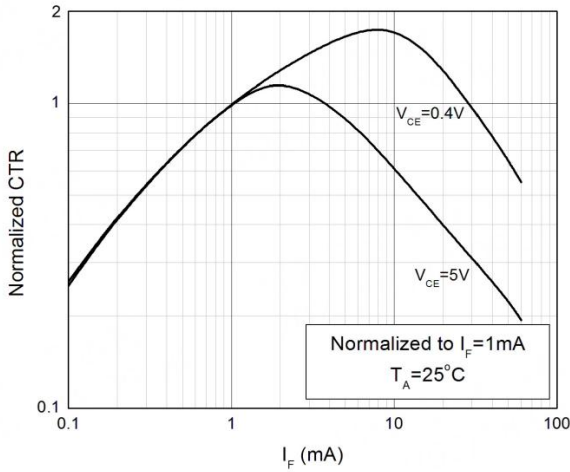


**Fig.6 Collector Current vs. Collector-emitter Voltage**

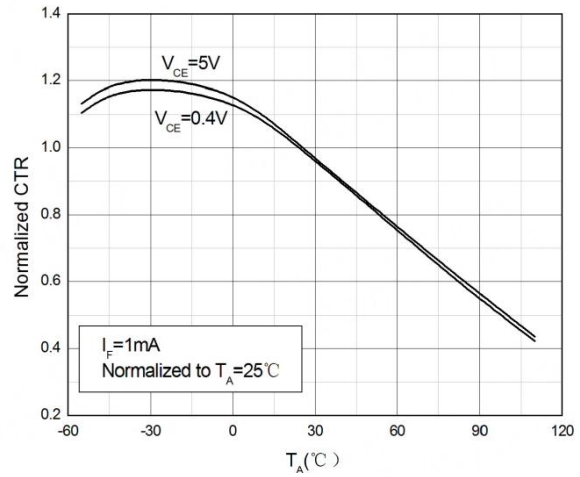


**CHARACTERISTIC CURVES**

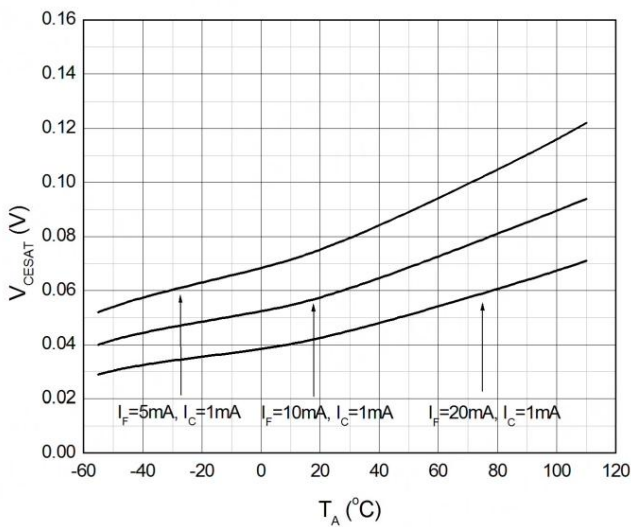
**Fig.7 Normalized Current Transfer Ratio vs. Forward Current**



**Fig.8 Normalized Current Transfer Ratio vs. Ambient Temperature**



**Fig.9 Collector-emitter Saturation Voltage vs. Ambient Temperature**



**Fig.10 Switching Time vs. Load Resistance**

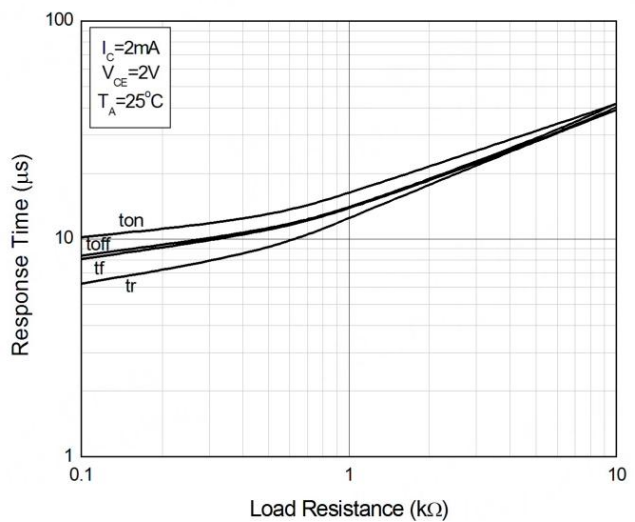
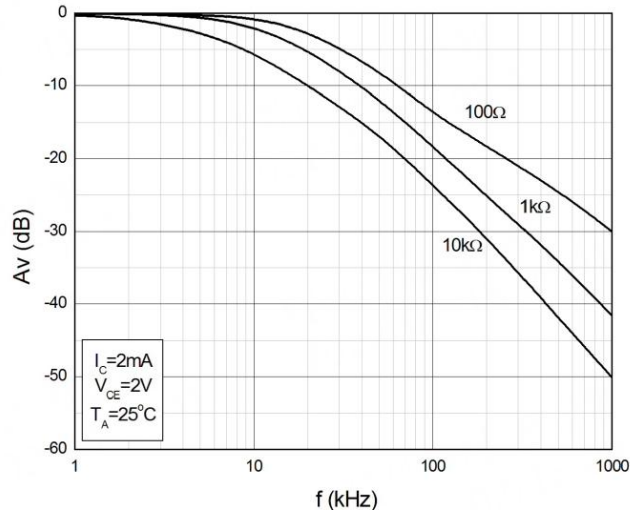


Fig.11 Frequency Response



TEST CIRCUITS

Fig.12 Test Circuits of Response Time

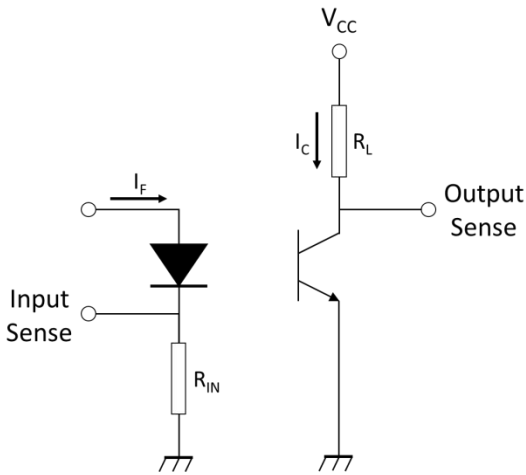


Fig.13 Curves of Response Time

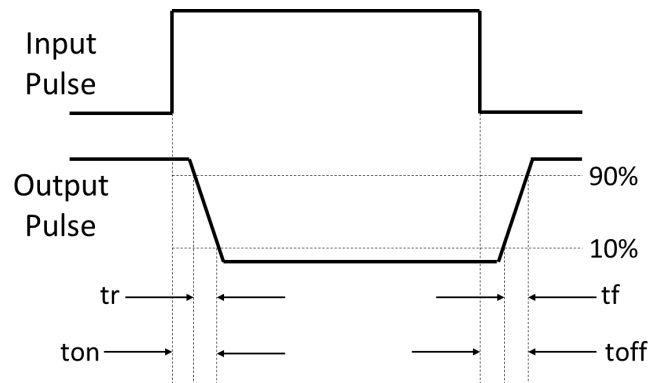
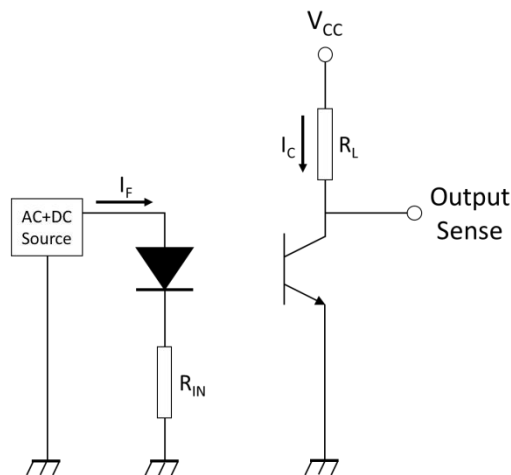
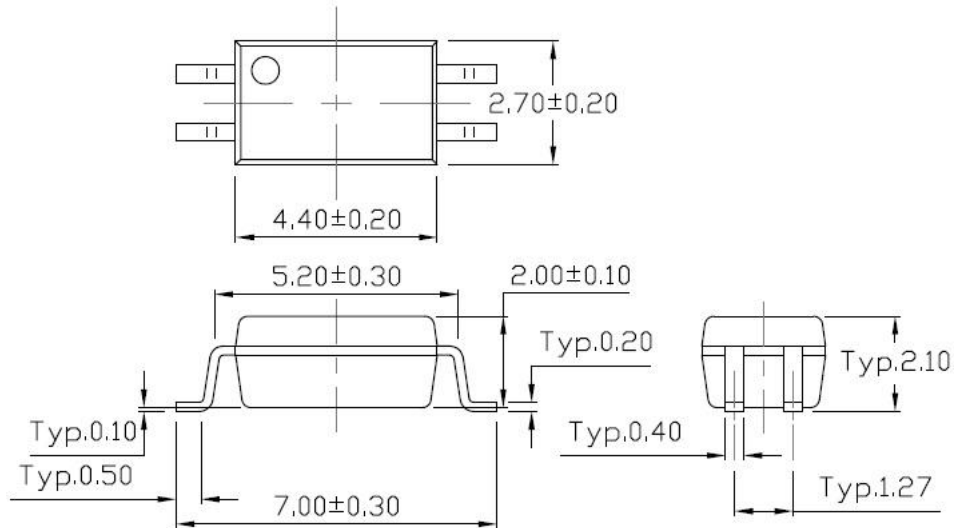


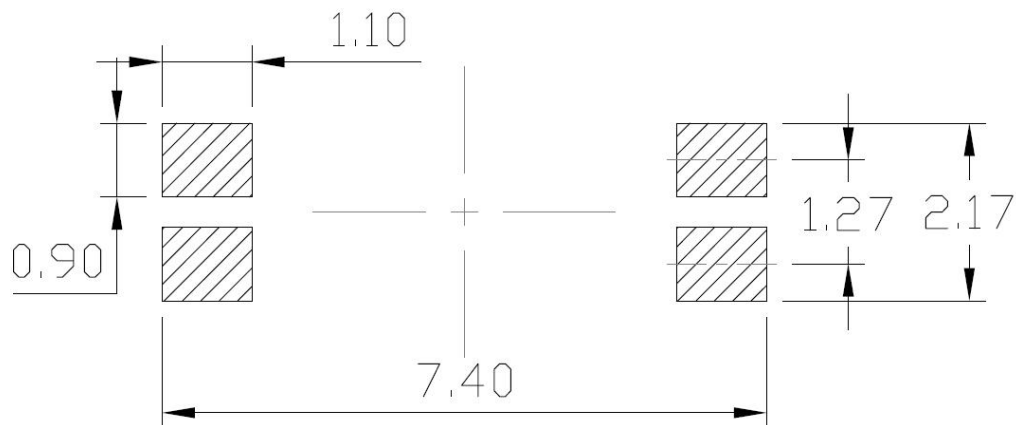
Fig.14 Test Circuits of Frequency Response



**PACKAGE DIMENSIONS (Dimensions in mm unless otherwise stated)**

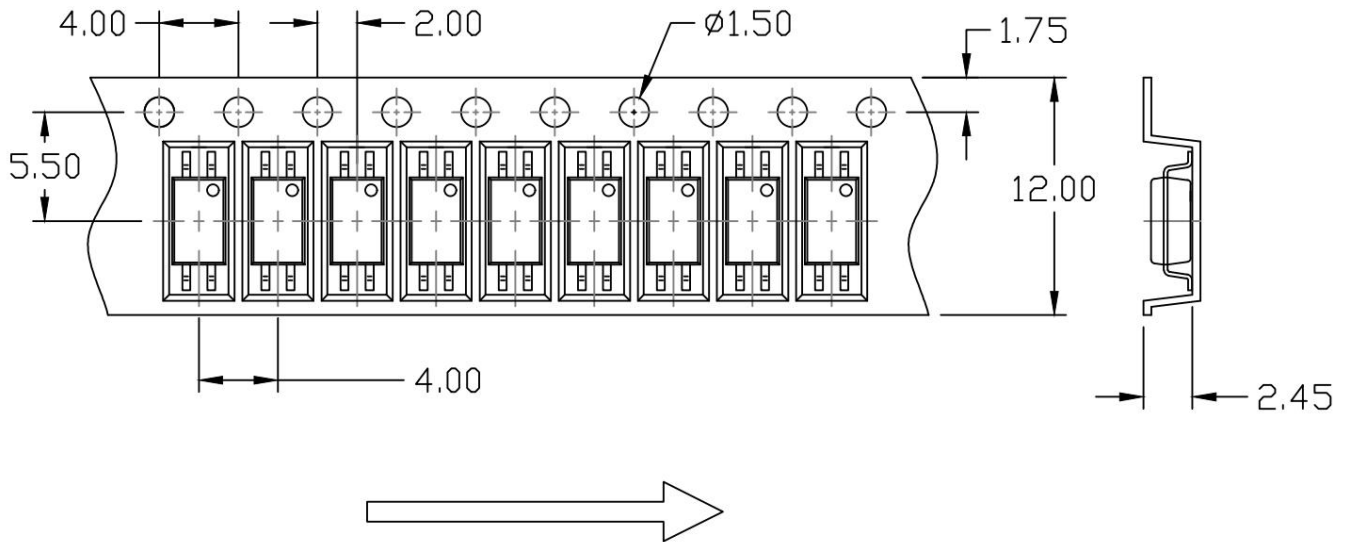


**Recommended Solder Mask (Dimensions in mm unless otherwise stated)**

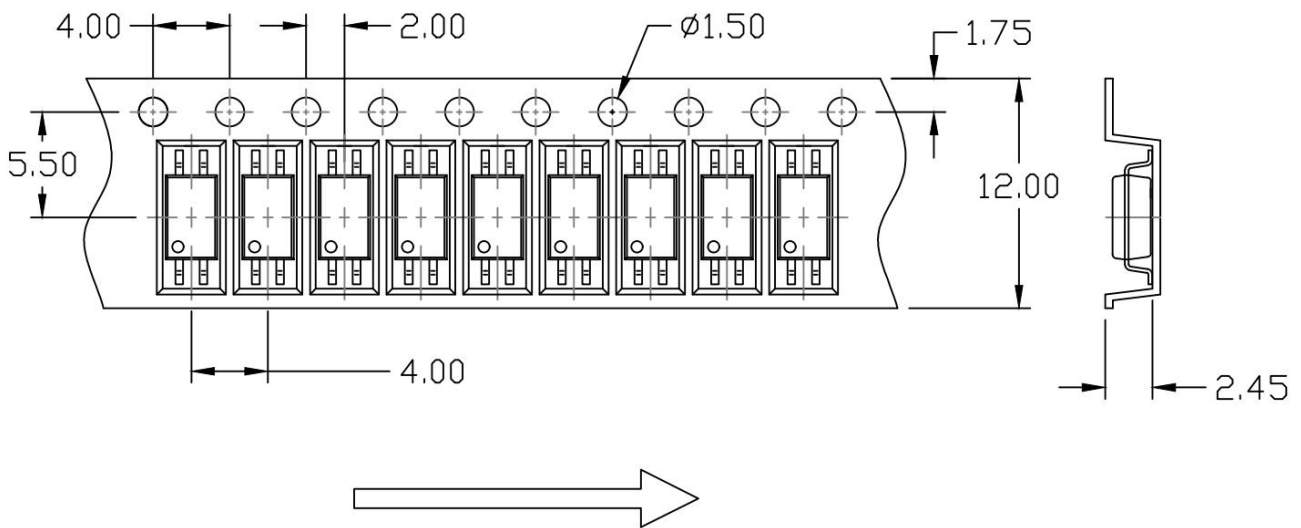


**CARRIER TAPE SPECIFICATIONS (Dimensions in mm unless otherwise stated)**

**Option T1**



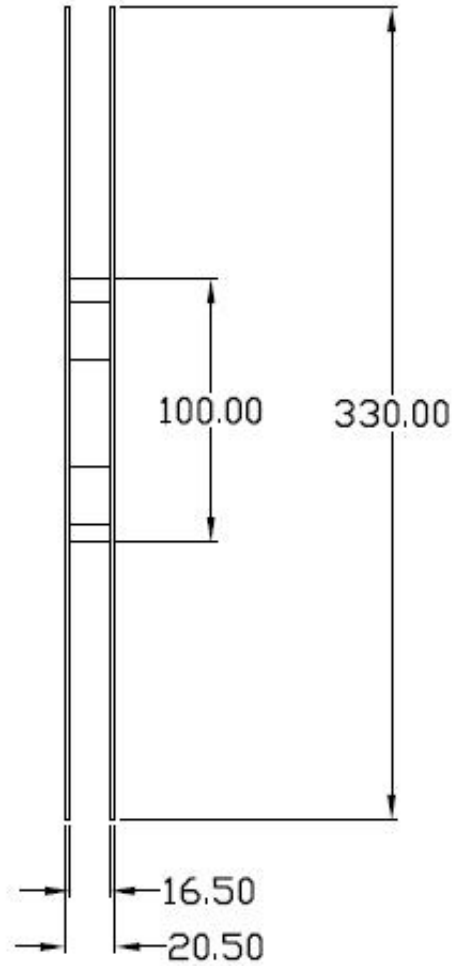
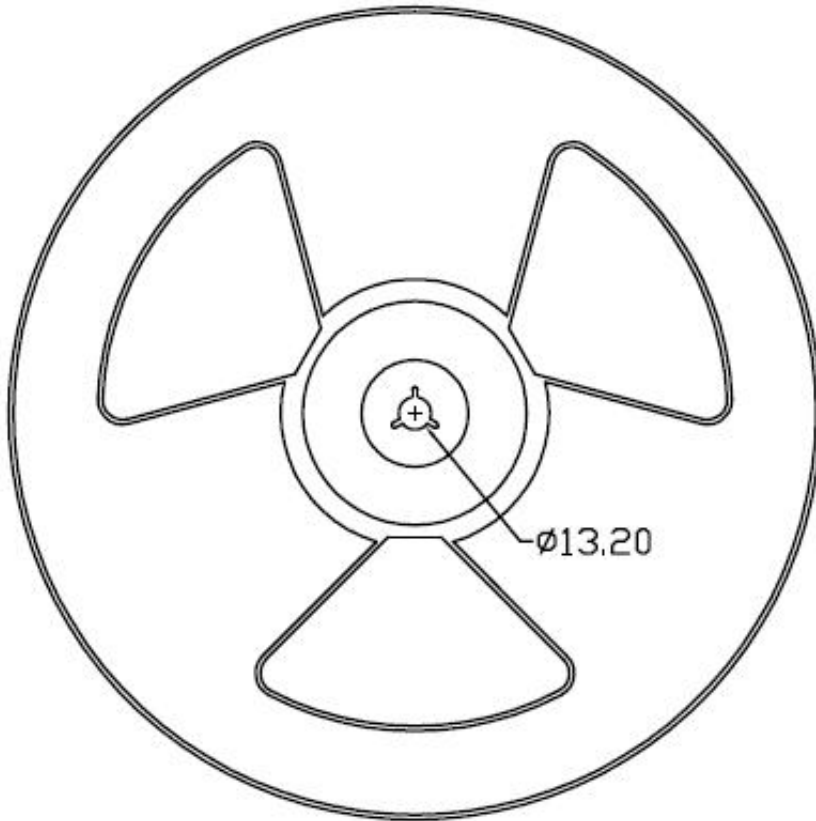
**Option T2**





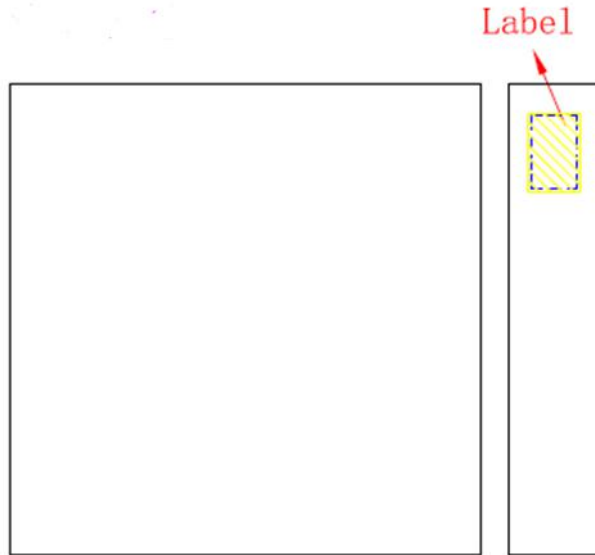
**REEL SPECIFICATIONS** (Dimensions in mm unless otherwise stated)

Option T1 & T2



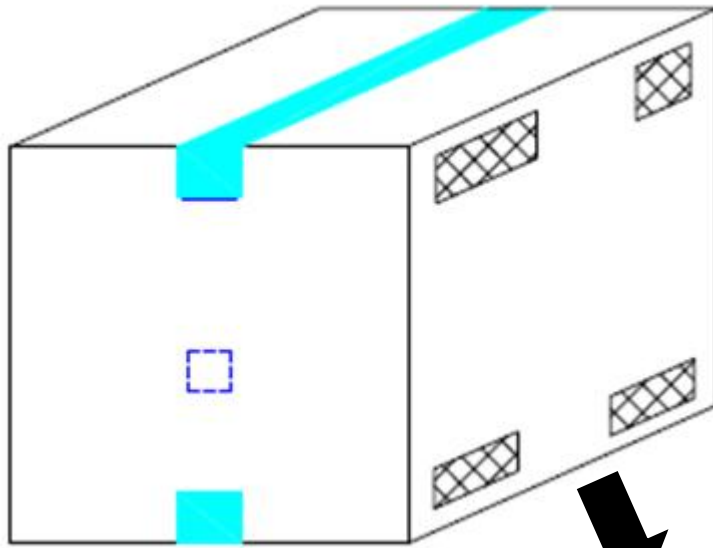
**BOX SPECIFICATIONS (Reel Type)**

**Inner Box**

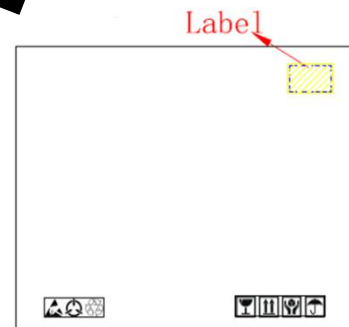


- L x W x H = 36cm x 36cm x 6.9cm

**Outer Box**

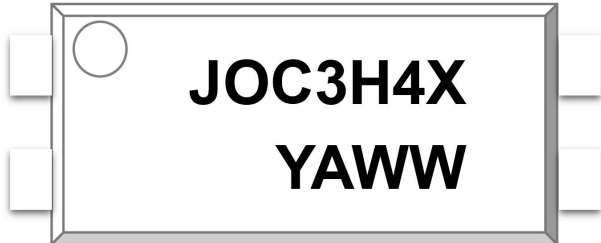


- L x W x H = 45cm x 38cm x 38cm



**ORDERING AND MARKING INFORMATION**

**MARKING INFORMATION**



**JOC** : Company Abbr.  
**3H4** : Part Number  
**X** : CTR Rank  
**Y** : Fiscal Year  
**A** : Manufacturing Code  
**WW** : Work Week

**ORDERING INFORMATION**

**JOC3H4X(Z)-G**

JOC – Company Abbr.  
 3H4 – Part Number  
 X – Rank (A/B or None)  
 Z – Tape and Reel Option (T1/T2)  
 G – Green

**LABEL INFORMATION**

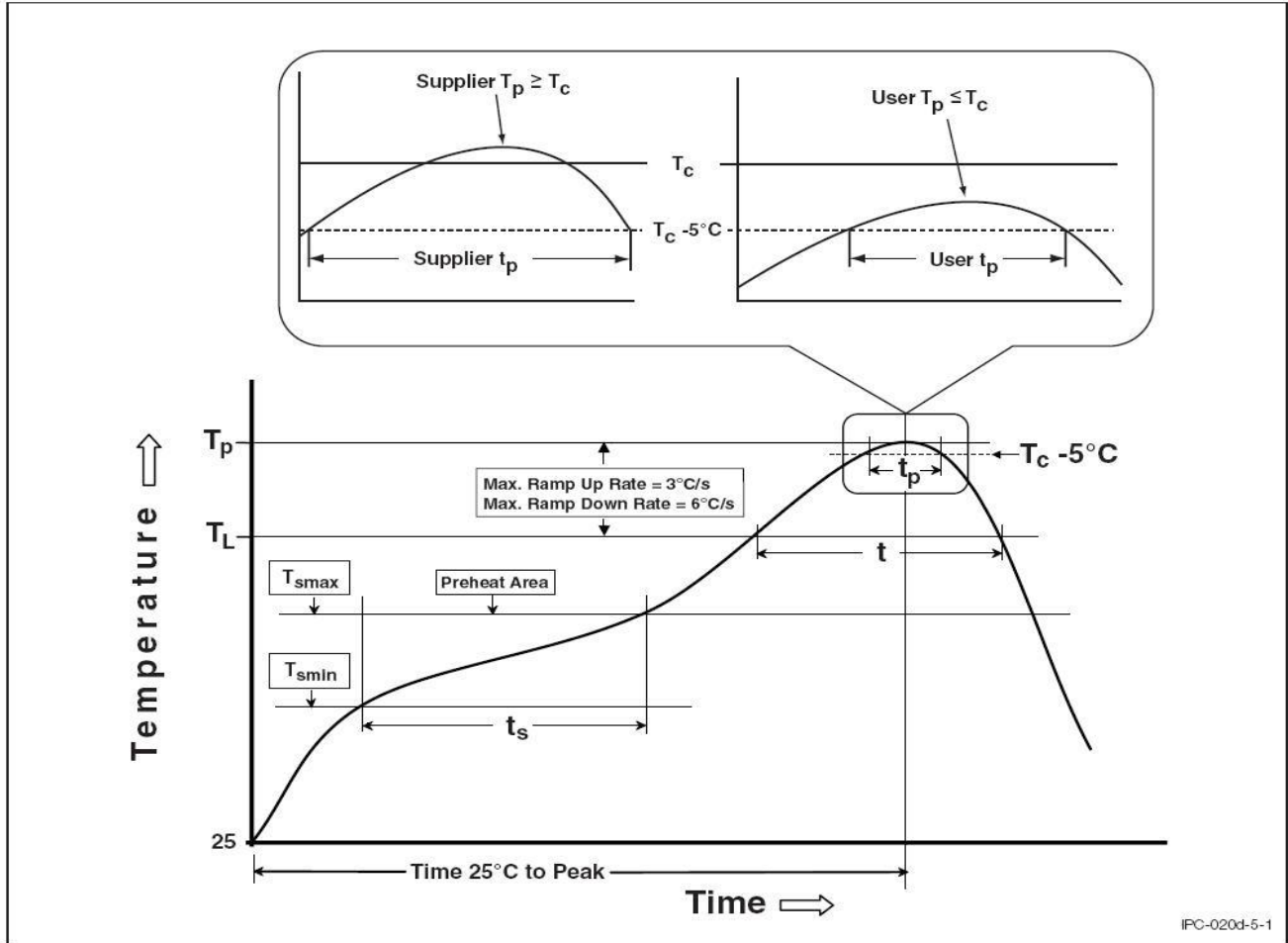


**PACKING QUANTITY**

Option	Quantity	Quantity – Inner box	Quantity – Outer box
T1	3000 Units/Reel	2 Reels/Inner box	10 Inner box/Outer box = 60k Units
T2	3000 Units/Reel	2 Reels/Inner box	10 Inner box/Outer box = 60k Units

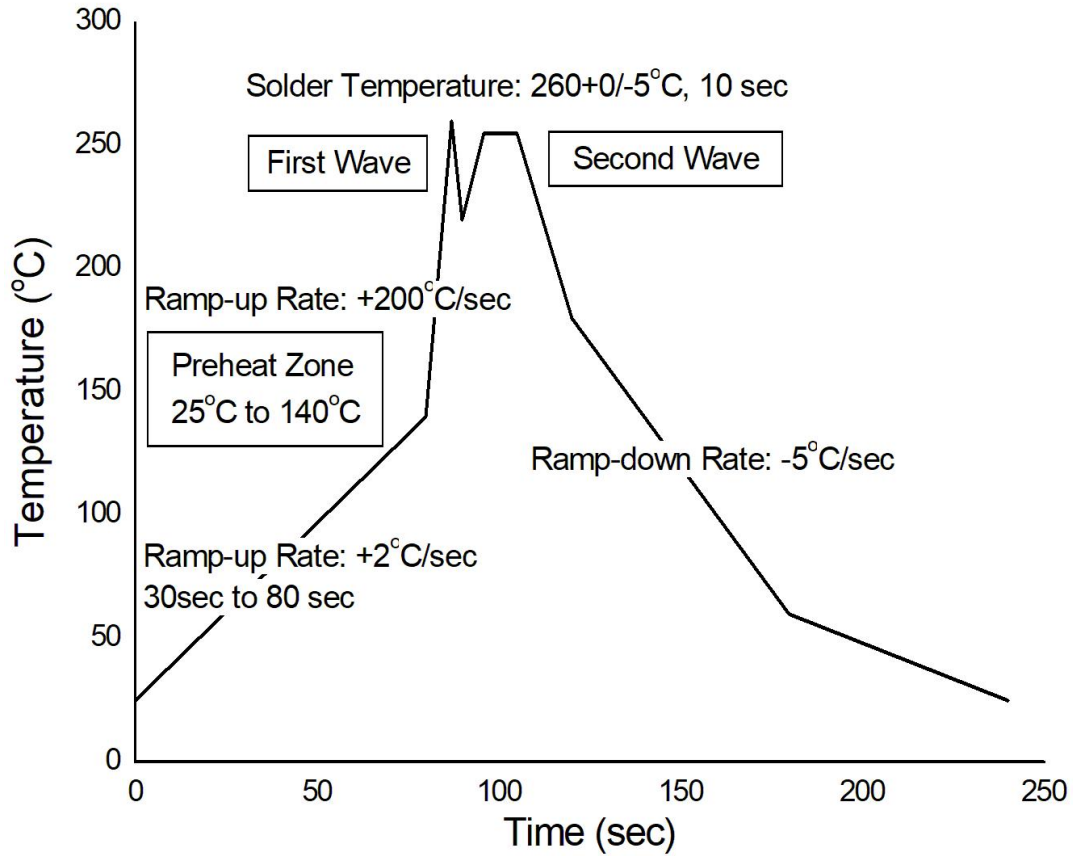
**REFLOW INFORMATION**

**REFLOW PROFILE**



Profile Feature	Sn-Pb Assembly Profile	Pb-Free Assembly Profile
Temperature Min. ( $T_{smin}$ )	100	150°C
Temperature Max. ( $T_{smax}$ )	150	200°C
Time ( $t_s$ ) from ( $T_{smin}$ to $T_{smax}$ )	60-120 seconds	60-120 seconds
Ramp-up Rate ( $t_L$ to $t_P$ )	3°C/second max.	3°C/second max.
Liquidous Temperature ( $T_L$ )	183°C	217°C
Time ( $t_L$ ) Maintained Above ( $T_L$ )	60 – 150 seconds	60 – 150 seconds
Peak Body Package Temperature	235°C +0°C / -5°C	260°C +0°C / -5°C
Time ( $t_P$ ) within 5°C of 260°C	20 seconds	30 seconds
Ramp-down Rate ( $T_P$ to $T_L$ )	6°C/second max	6°C/second max
Time 25°C to Peak Temperature	6 minutes max.	8 minutes max.

**TEMPERATURE PROFILE OF SOLDERING**  
**WAVE SOLDERING (JESD22-A111 COMPLIANT)**



**HAND SOLDERING BY SOLDERING IRON**

Soldering Temperature	380+0/-5°C
Soldering Time	3 sec max.

- One time soldering is recommended for all soldering method.
- Do not solder more than three times for IR reflow soldering.

**DISCLAIMER**

- JIEJIE is continually improving the quality, reliability, function and design. JIEJIE reserves the right to make changes without further notices.
- The characteristic curves shown in this datasheet are representing typical performance which are not guaranteed.
- JIEJIE makes no warranty, representation or guarantee regarding the suitability of the products for any particular purpose or the continuing production of any product. To the maximum extent permitted by applicable law, JIEJIE disclaims (a) any and all liability arising out of the application or use of any product, (b) any and all liability, including without limitation special, consequential or incidental damages, and (c) any and all implied warranties, including warranties of fitness for particular
- The products shown in this publication are designed for the general use in electronic applications such as office automation, equipment, communications devices, audio/visual equipment, electrical application and instrumentation purpose, non-infringement and merchantability.
- This product is not intended to be used for military, aircraft, automotive, medical, life sustaining or lifesaving applications or any other application which can result in human injury or death.
- Please contact JIEJIE sales agent for special application request.
- Immerge unit's body in solder paste is not recommended.
- Parameters provided in datasheets may vary in different applications and performance may vary over time. All operating parameters, including typical parameters, must be validated in each customer application by the customer's technical experts. Product specifications do not expand or otherwise modify JIEJIE's terms and conditions of purchase, including but not limited to the warranty expressed therein.
- Discoloration might be occurred on the package surface after soldering, reflow or long-time use. It neither impacts the performance nor reliability.