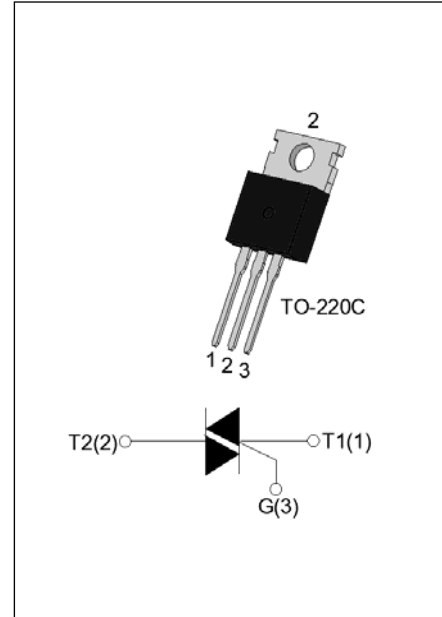

JST24C-800C 25A TRIAC

Rev.A.1.0

DESCRIPTION:

The JST24C-800C triac is suitable for general purpose AC switching. It can be used as an ON/OFF function in applications such as heating regulation, induction motor starting circuits, for phase control operation in light dimmers, motor speed controllers. From T2 terminals to external heatsink. Package TO-220C is RoHS compliant.

MAIN FEATURES

| Symbol | Value | Unit |
|-----------------------|-------------|------|
| $I_{T(RMS)}$ | 25 | A |
| V_{DRM}/V_{RRM} | 800 | V |
| $I_{GT\ I/II/III/IV}$ | 25/25/25/50 | mA |

ABSOLUTE MAXIMUM RATINGS

| Parameter | | Symbol | Value | Unit |
|--|--------|--------------|---------|------------------------|
| Storage junction temperature range | | T_{stg} | -40-150 | °C |
| Operating junction temperature range | | T_j | -40-125 | °C |
| Repetitive peak off-state voltage ($T_j=25^\circ\text{C}$) | | V_{DRM} | 800 | V |
| Repetitive peak reverse voltage ($T_j=25^\circ\text{C}$) | | V_{RRM} | 800 | V |
| RMS on-state current ($T_c \leq 100^\circ\text{C}$) | | $I_{T(RMS)}$ | 25 | A |
| Non repetitive surge peak on-state current (full cycle , $t_p=20\text{ms}$, $T_j=25^\circ\text{C}$) | | I_{TSM} | 250 | A |
| Non repetitive surge peak on-state current (full cycle , $t_p=16.6\text{ms}$, $T_j=25^\circ\text{C}$) | | | 275 | |
| I^2t value for fusing ($t_p=10\text{ms}$, $T_j=25^\circ\text{C}$) | | I^2t | 340 | A^2s |
| Critical rate of rise of on-state current ($I_G=2 \times I_{GT}$, $f=100\text{Hz}$, $T_j=125^\circ\text{C}$) | I - II | di/dt | 80 | $\text{A}/\mu\text{s}$ |
| | III-IV | | 40 | |
| Peak gate current ($t_p=20\mu\text{s}$, $T_j=125^\circ\text{C}$) | | I_{GM} | 4 | A |
| Average gate power dissipation ($T_j=125^\circ\text{C}$) | | $P_{G(AV)}$ | 0.5 | W |
| Peak gate power | | P_{GM} | 10 | W |
| Peak pulse voltage ($T_j=25^\circ\text{C}$; non-repetitive,off-state;FIG.7) | | V_{pp} | 2 | kV |

ELECTRICAL CHARACTERISTICS ($T_j=25^{\circ}\text{C}$ unless otherwise specified)

| Symbol | Test Condition | Quadrant | Value | | Unit |
|-------------|--|--------------|-------|-----|------------------------|
| I_{GT} | $V_D=12\text{V } R_L=33\Omega$ | I - II - III | MAX. | 25 | mA |
| | | IV | | 50 | |
| V_{GT} | | ALL | MAX. | 1 | V |
| V_{GD} | $V_D=V_{DRM} T_j=125^{\circ}\text{C}$ $R_L=3.3\text{K}\Omega$ | ALL | MIN. | 0.2 | V |
| I_L | $I_G=1.2I_{GT}$ | I - III - IV | MAX. | 70 | mA |
| | | II | | 100 | |
| I_H | $I_T=500\text{mA}$ | | MAX. | 60 | mA |
| dV/dt | $V_D=540\text{V}$ Gate Open $T_j=125^{\circ}\text{C}$ | | MIN. | 500 | $\text{V}/\mu\text{s}$ |
| $(dV/dt)_c$ | $(dI/dt)_c=13.3\text{A/ms}$, $T_j=125^{\circ}\text{C}$ | | MIN. | 6 | $\text{V}/\mu\text{s}$ |
| t_{on} | $I_G=80\text{mA } I_A=400\text{mA } I_R=40\text{mA}$ $T_j=25^{\circ}\text{C}$ | | TYP. | 3 | μs |
| t_{off} | | | | 50 | |

STATIC CHARACTERISTICS

| Symbol | Parameter | | Value(MAX.) | Unit |
|-----------|---|---------------------------|-------------|------------------|
| V_{TM} | $I_{TM}=35\text{A } t_p=380\mu\text{s}$ | $T_j=25^{\circ}\text{C}$ | 1.5 | V |
| V_{TO} | Threshold voltage | $T_j=125^{\circ}\text{C}$ | 0.75 | V |
| R_D | Dynamic resistance | $T_j=125^{\circ}\text{C}$ | 18 | $\text{m}\Omega$ |
| I_{DRM} | $V_D=V_{DRM} V_R=V_{RRM}$ | $T_j=25^{\circ}\text{C}$ | 5 | μA |
| I_{RRM} | | $T_j=125^{\circ}\text{C}$ | 2 | mA |

THERMAL RESISTANCES

| Symbol | Parameter | Value | Unit |
|---------------|--------------------------|-------|-----------------------------|
| $R_{th(j-c)}$ | junction to case (AC) | 0.7 | $^{\circ}\text{C}/\text{W}$ |
| $R_{th(j-a)}$ | junction to ambient (AC) | 60 | $^{\circ}\text{C}/\text{W}$ |

ORDERING INFORMATION

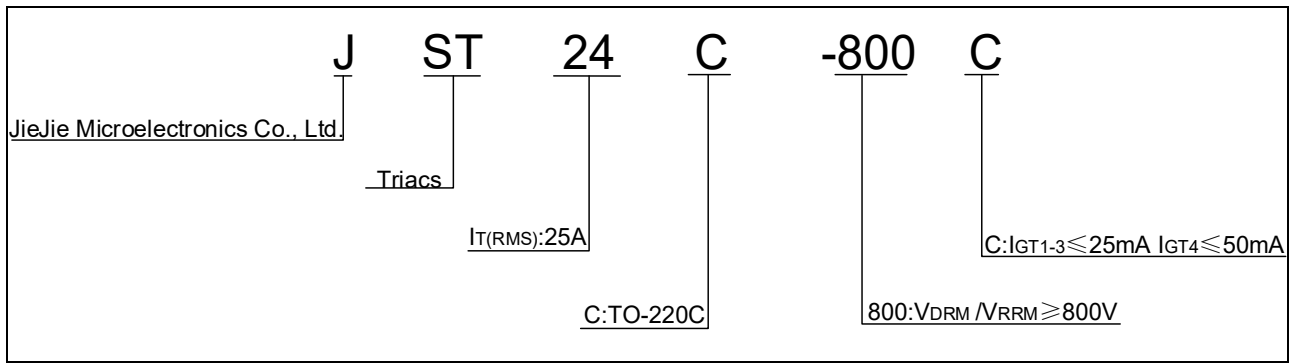

MARKING

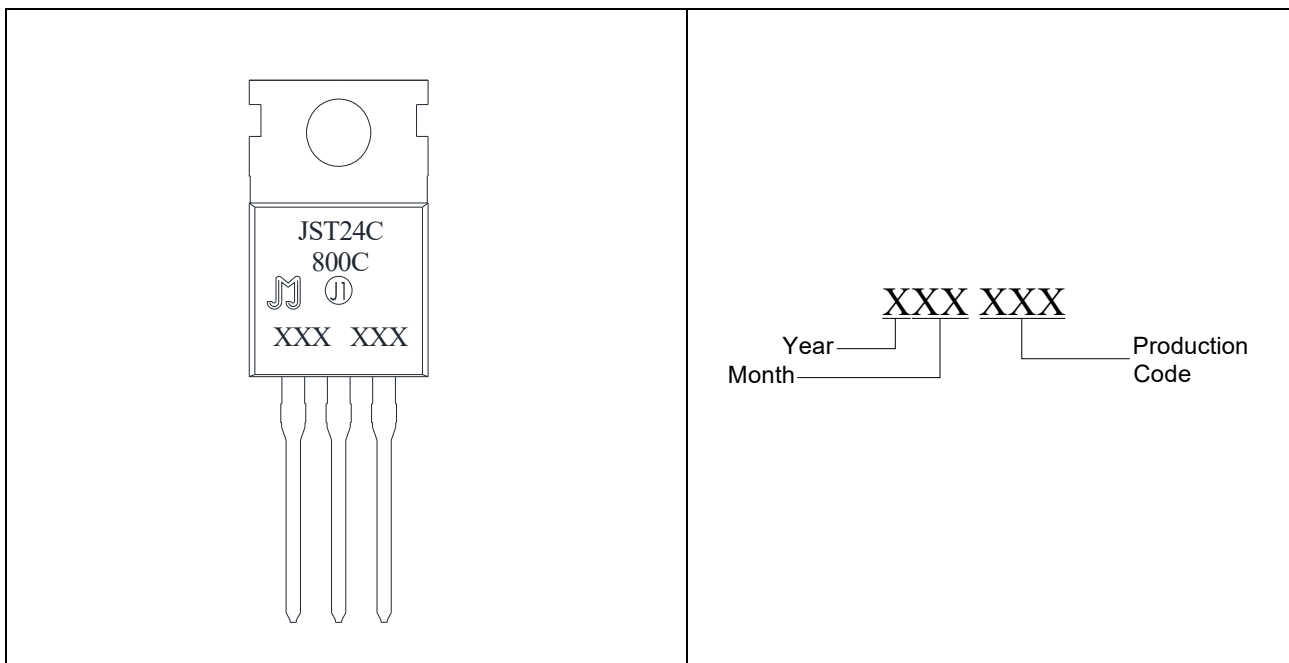

FIG.1 Maximum power dissipation versus RMS on-state current

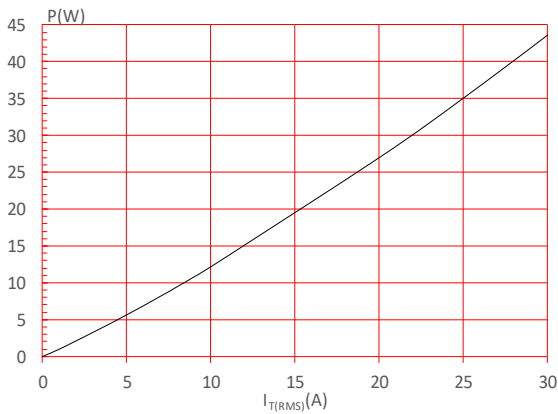

FIG.2: RMS on-state current versus case temperature

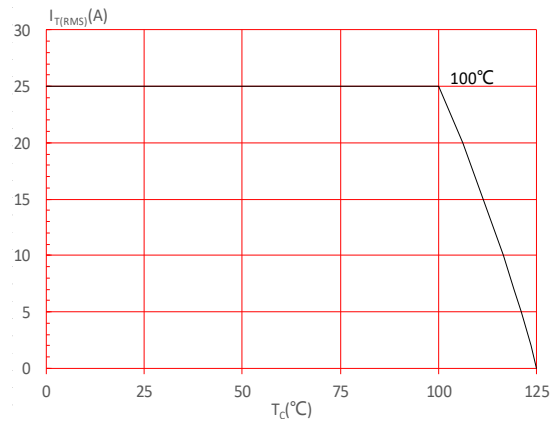

FIG.3: Surge peak on-state current versus number of cycles

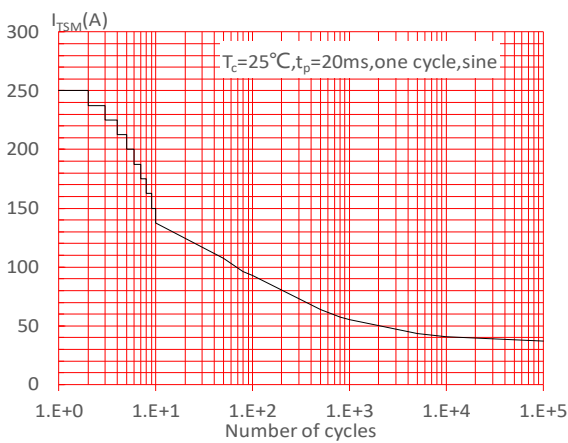

FIG.4: On-state characteristics

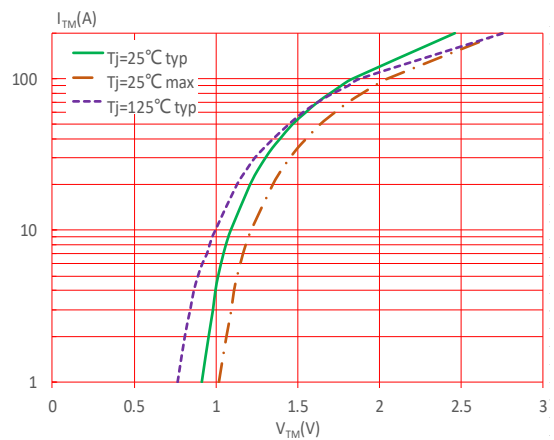

FIG.5: Non-repetitive surge peak on-state current for a sinusoidal pulse with width $t_p < 20\text{ms}$, and corresponding value of I^2t (I - II: $di/dt < 80\text{A}/\mu\text{s}$; III-IV: $di/dt < 40\text{A}/\mu\text{s}$)

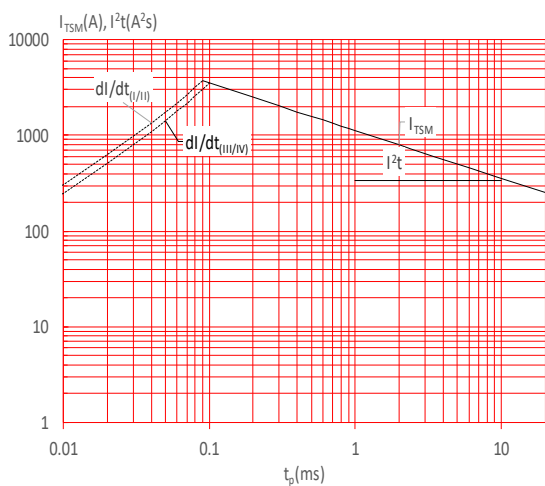

FIG.6: Relative variations of gate trigger current, holding current and latching current versus junction temperature

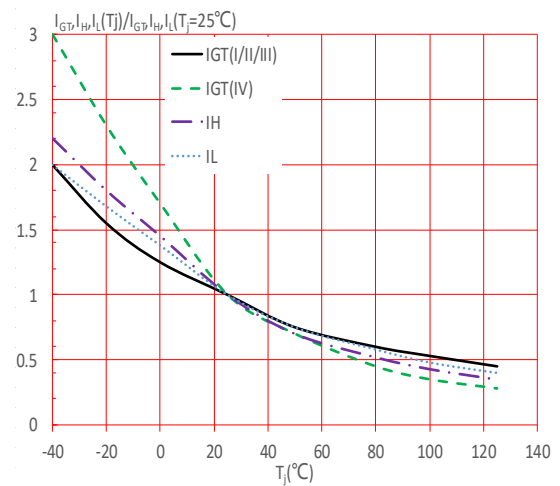
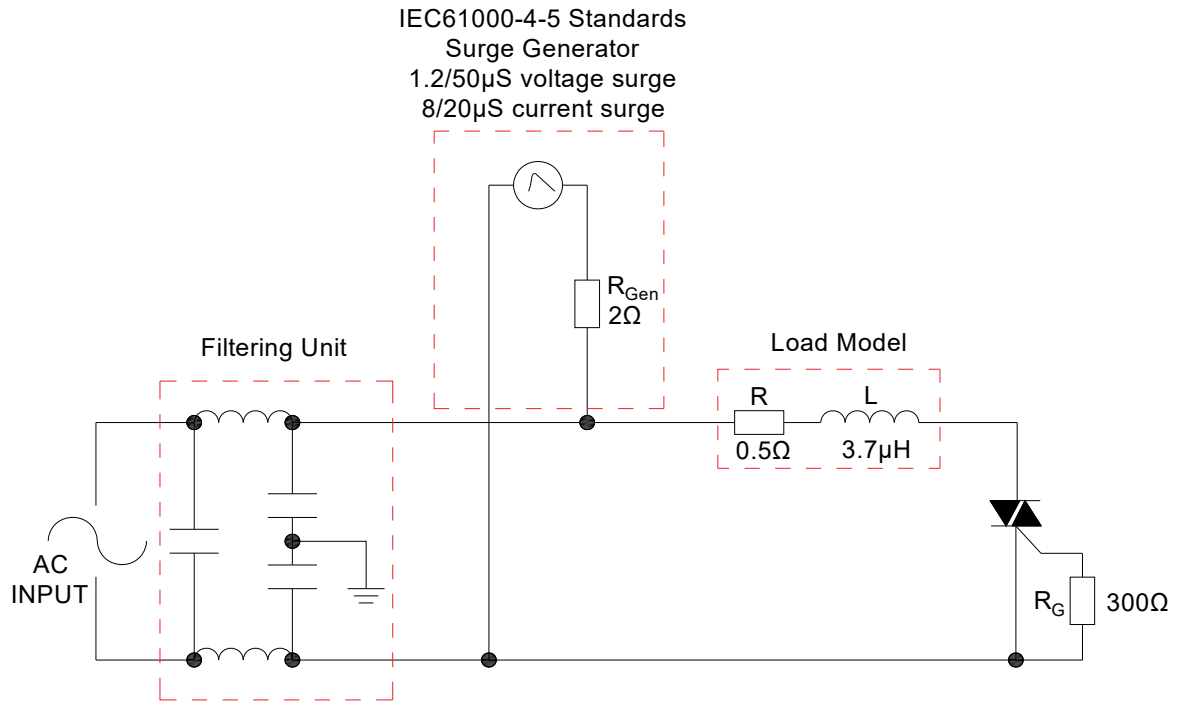

FIG.7: Test circuit for inductive and resistive loads to IEC-61000-4-5 standards



SHAPING AND SOLDERING PARAMETERS

Refer to 《Instructions for installation of plastic-sealed in-line power devices》 released by JieJie.

ORDERING INFORMATION

| Order code | Voltage V_{DRM}/V_{RRM} (V) | IGT(mA) | | Package | Base qty. (pcs) | Delivery mode |
|-------------|----------------------------------|------------|----|---------|--------------------|---------------|
| | | I -II -III | IV | | | |
| JST24C-800C | 800 | 25 | 50 | TO-220C | 50 | Tube |

Document Revision History

| Date | Revision | Changes |
|--------------|----------|--------------|
| Apr.14, 2023 | A.1.0 | Last updated |

PACKAGE MECHANICAL DATA

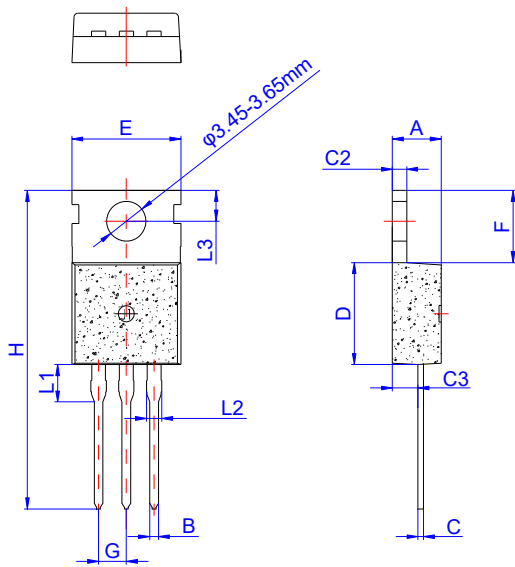

| Ref. | Dimensions | | | | | |
|------|-------------|------|------|--------|------|-------|
| | Millimeters | | | Inches | | |
| | Min. | Typ. | Max. | Min. | Typ. | Max. |
| A | 4.40 | | 4.60 | 0.173 | | 0.181 |
| B | 0.70 | | 0.90 | 0.028 | | 0.035 |
| C | 0.45 | | 0.60 | 0.018 | | 0.024 |
| C2 | 1.25 | | 1.35 | 0.049 | | 0.053 |
| C3 | 2.20 | | 2.60 | 0.087 | | 0.102 |
| D | 8.90 | | 9.90 | 0.350 | | 0.390 |
| E | 9.90 | | 10.3 | 0.390 | | 0.406 |
| F | 6.30 | | 6.90 | 0.248 | | 0.272 |
| G | 2.40 | | 2.70 | 0.094 | | 0.106 |
| H | 28.0 | | 29.8 | 1.102 | | 1.173 |
| L1 | 2.70 | | 3.30 | 0.106 | | 0.130 |
| L2 | 1.14 | | 1.70 | 0.045 | | 0.067 |
| L3 | 2.65 | | 2.95 | 0.104 | | 0.116 |

DELIVERY MODE

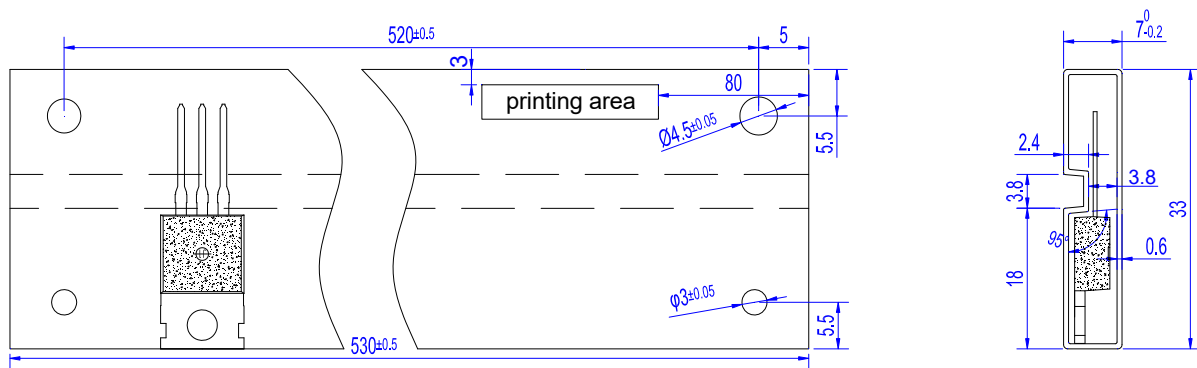

| PACKAGE | OUTLINE | TUBE (PCS) | INNER BOX (PCS) | PER CARTON |
|---------|---------|------------|-----------------|------------|
| TO-220C | TUBE | 50 | 1,000 | 5,000 |

Information furnished in this document is believed to be accurate and reliable. However, Jiangsu JieJie Microelectronics Co., Ltd assumes no responsibility for the consequences of use without consideration for such information nor use beyond it. Information mentioned in this document is subject to change without notice, apart from that when an agreement is signed, Jiangsu JieJie complies with the agreement.

Products and information provided in this document have no infringement of patents. Jiangsu JieJie assumes no responsibility for any infringement of other rights of third parties which may result from the use of such products and information. This document supersedes and replaces all information previously supplied.



is a registered trademark of Jiangsu JieJie Microelectronics Co., Ltd.

Copyright ©2023 Jiangsu JieJie Microelectronics Co., Ltd. Printed All rights reserved.