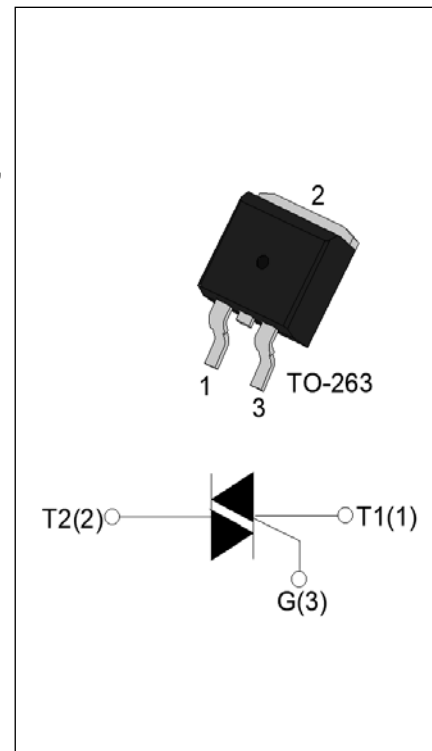

DESCRIPTION:

The T2050H-6E triac is suitable for general purpose AC switching. It can be used as an ON/OFF function in applications such as heating regulation, induction motor starting circuits, for phase control operation in light dimmers, motor speed controllers. Compared to traditional triacs, T2050H-6E provides a very high switching capability up to junction temperatures of 150 °C. Package TO-263 is RoHS compliant.

MAIN FEATURES

| Symbol | Value | Unit |
|--------------------|----------|------|
| $I_{T(RMS)}$ | 20 | A |
| V_{DRM}/V_{RRM} | 600 | V |
| $I_{GT\ I/II/III}$ | 50/50/50 | mA |

ABSOLUTE MAXIMUM RATINGS

| Parameter | Symbol | Value | Unit |
|--|--------------|---------|------------------------|
| Storage junction temperature range | T_{stg} | -40-150 | °C |
| Operating junction temperature range | T_j | -40-150 | °C |
| Repetitive peak off-state voltage ($T_j=25^\circ\text{C}$) | V_{DRM} | 600 | V |
| Repetitive peak reverse voltage ($T_j=25^\circ\text{C}$) | V_{RRM} | 600 | V |
| RMS on-state current ($T_c \leq 121^\circ\text{C}$) | $I_{T(RMS)}$ | 20 | A |
| Non repetitive surge peak on-state current (full cycle , $t_p=20\text{ms}$, $T_j=25^\circ\text{C}$) | I_{TSM} | 200 | A |
| Non repetitive surge peak on-state current (full cycle , $t_p=16.6\text{ms}$, $T_j=25^\circ\text{C}$) | | 220 | |
| I^2t value for fusing ($t_p=10\text{ms}$, $T_j=25^\circ\text{C}$) | I^2t | 200 | A^2s |
| Critical rate of rise of on-state current ($I_G=2 \times I_{GT}$, $f=100\text{Hz}$, $T_j=150^\circ\text{C}$) | di/dt | 100 | $\text{A}/\mu\text{s}$ |
| Peak gate current ($t_p=20\mu\text{s}$, $T_j=150^\circ\text{C}$) | I_{GM} | 4 | A |
| Average gate power dissipation ($T_j=150^\circ\text{C}$) | $P_{G(AV)}$ | 1 | W |
| Peak gate power | P_{GM} | 10 | W |

| | | | |
|--|----------|---|----|
| Peak pulse voltage ($T_j=25^\circ\text{C}$; non-repetitive, off-state; FIG.8) | V_{pp} | 4 | kV |
|--|----------|---|----|

ELECTRICAL CHARACTERISTICS ($T_j=25^\circ\text{C}$ unless otherwise specified)

| Symbol | Test Condition | Quadrant | Value | | Unit |
|-------------|--|--------------|-------|------|------------------|
| I_{GT} | $V_D=12\text{V}$ $R_L=33\Omega$ | I - II - III | MAX. | 50 | mA |
| V_{GT} | | I - II - III | MAX. | 1 | V |
| V_{GD} | $V_D=V_{DRM}$ $T_j=150^\circ\text{C}$ $R_L=3.3\text{K}\Omega$ | I - II - III | MIN. | 0.2 | V |
| I_L | $I_G=1.2I_{GT}$ | I - III | MAX. | 70 | mA |
| | | II | | 100 | |
| I_H | $I_T=500\text{mA}$ | | MAX. | 60 | mA |
| dV/dt | $V_D=400\text{V}$ Gate Open $T_j=150^\circ\text{C}$ | | MIN. | 2200 | V/ μs |
| $(dI/dt)_c$ | $(dV/dt)_c=20\text{V}/\mu\text{s}$, $T_j=150^\circ\text{C}$ | | MIN. | 30 | A/ms |
| t_{on} | $I_G=80\text{mA}$ $I_A=400\text{mA}$ $I_R=40\text{mA}$ $T_j=25^\circ\text{C}$ | | TYP. | 12 | μs |
| t_{off} | | | | 90 | |

STATIC CHARACTERISTICS

| Symbol | Parameter | | Value(MAX.) | Unit |
|-----------|--|-------------------------|-------------|------------------|
| V_{TM} | $I_{TM}=28\text{A}$ $t_p=380\mu\text{s}$ | $T_j=25^\circ\text{C}$ | 1.4 | V |
| V_{TO} | Threshold voltage | $T_j=150^\circ\text{C}$ | 0.71 | V |
| R_D | Dynamic resistance | $T_j=150^\circ\text{C}$ | 22 | $\text{m}\Omega$ |
| I_{DRM} | $V_D=V_{DRM}$ $V_R=V_{RRM}$ | $T_j=25^\circ\text{C}$ | 5 | μA |
| I_{RRM} | | $T_j=150^\circ\text{C}$ | 2.5 | mA |

THERMAL RESISTANCES

| Symbol | Parameter | Value | Unit |
|---------------|--|-------|---------------------------|
| $R_{th(j-c)}$ | junction to case (AC) | 1.1 | $^\circ\text{C}/\text{W}$ |
| $R_{th(j-a)}$ | junction to ambient (AC, in free air, $S=2\text{cm}^2$) | 45 | $^\circ\text{C}/\text{W}$ |

ORDERING INFORMATION

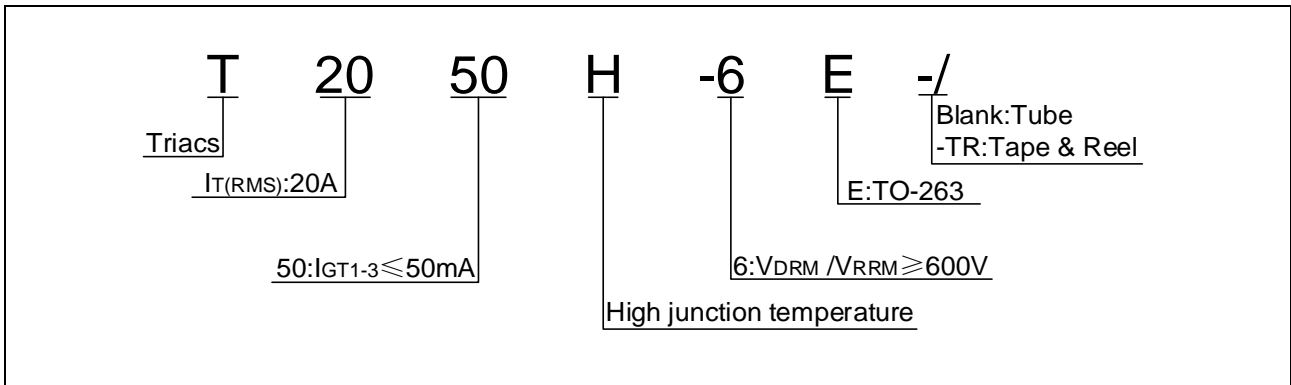

MARKING

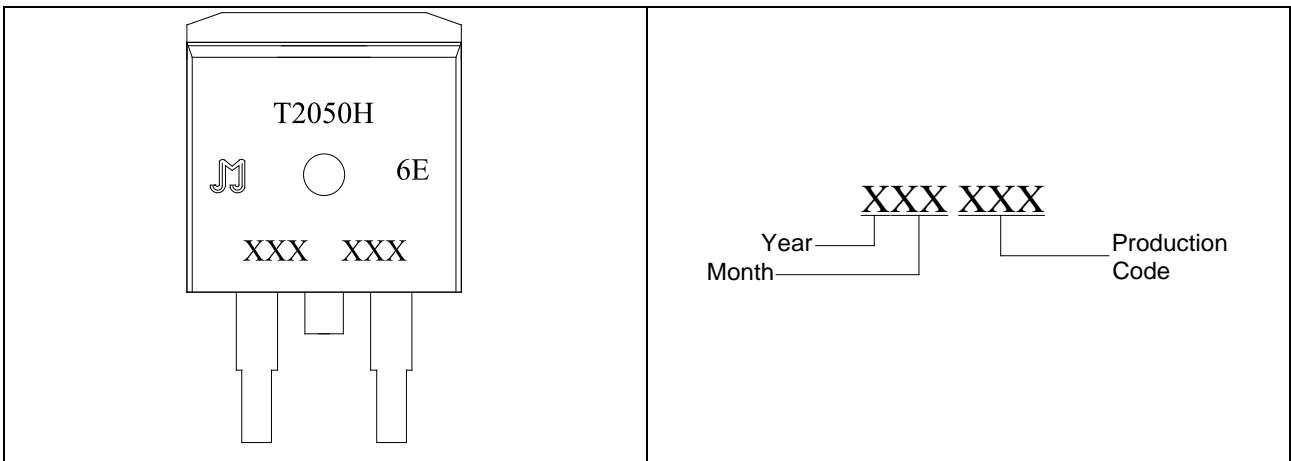

FIG.1 Maximum power dissipation versus RMS on-state current

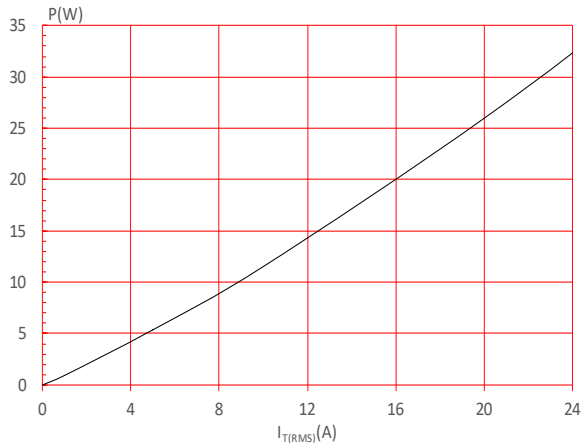

FIG.3: RMS on-state current versus ambient temperature (printed circuit board FR4,copper thickness:35μm)(full cycle)

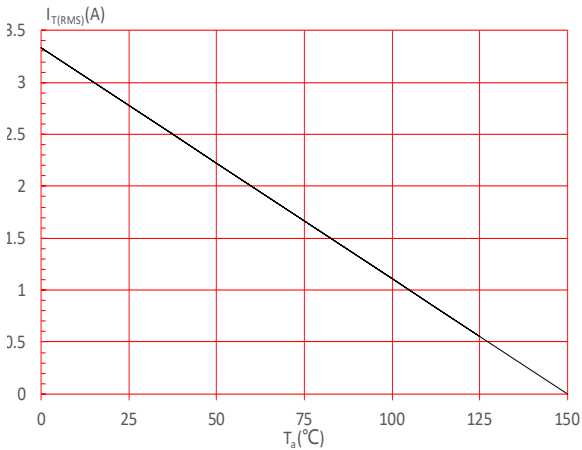

FIG.5: On-state characteristics

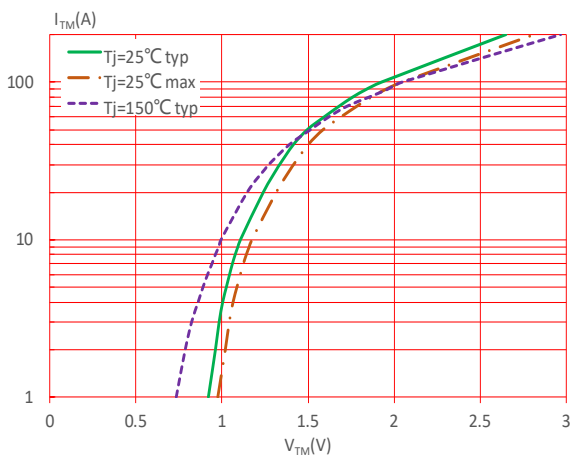

FIG.2: RMS on-state current versus case temperature

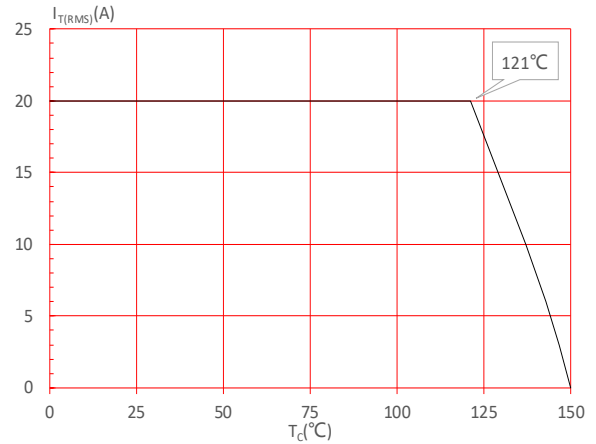

FIG.4: Surge peak on-state current versus number of cycles

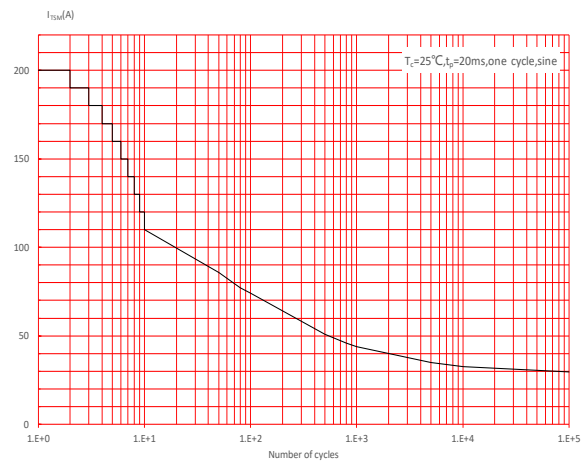

FIG.6: Non-repetitive surge peak on-state current for a sinusoidal pulse with width $t_p < 20\text{ms}$, and corresponding value of I^2t ($dI/dt < 100\text{A}/\mu\text{s}$)

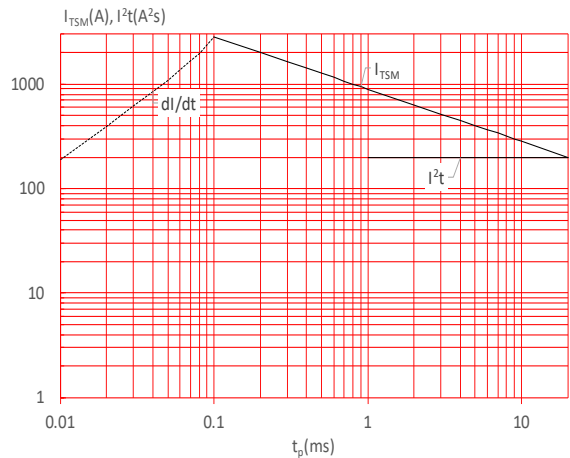

FIG.7: Relative variations of gate trigger current, holding current and latching current versus junction temperature

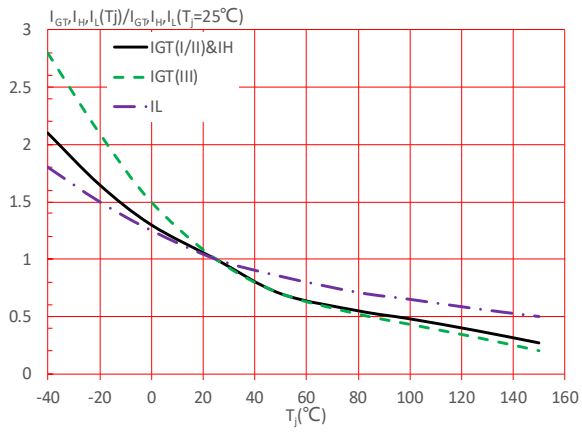
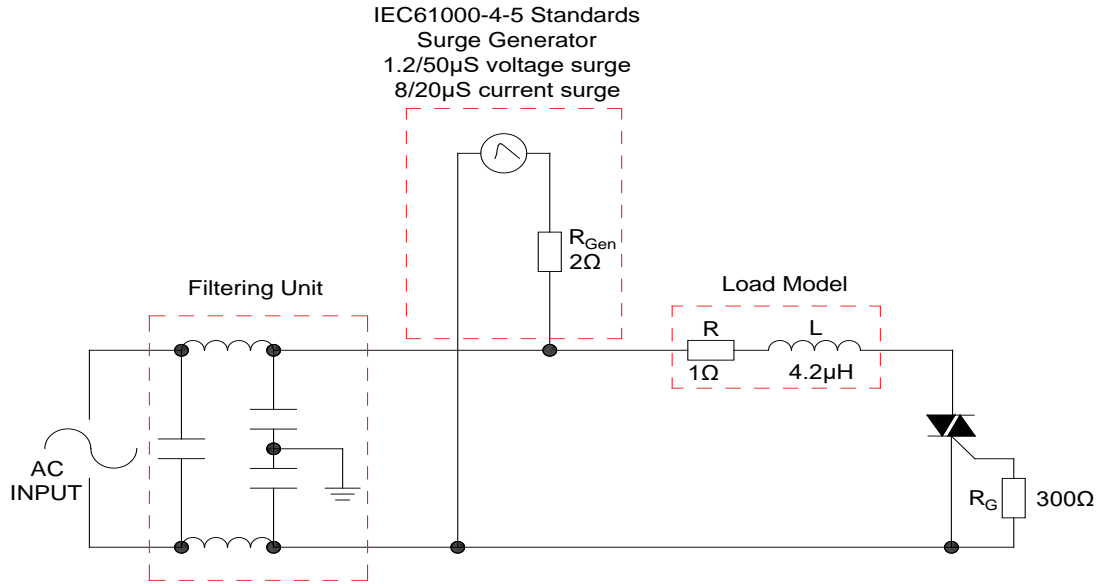
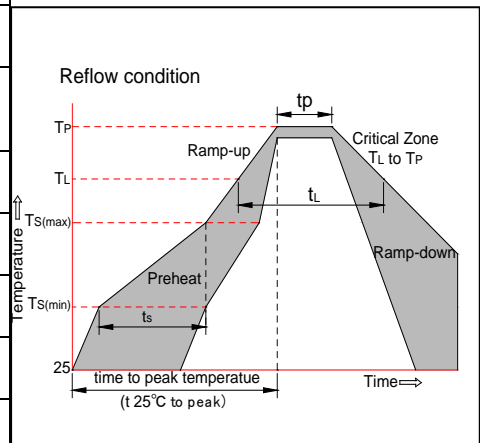

FIG.8: Test circuit for inductive and resistive loads to IEC-61000-4-5 standards



SOLDERING PARAMETERS

| | | |
|---|-----------------------------------|---|
| Reflow Condition | | Pb-Free assembly (see figure at right) |
| Pre Heat | -Temperature Min ($T_{s(min)}$) | +150°C |
| | -Temperature Max($T_{s(max)}$) | +200°C |
| | -Time (Min to Max) (ts) | 60-180 secs. |
| Average ramp up rate (Liquidus Temp (T_L) to peak) | | 3°C/sec. Max |
| $T_{s(max)}$ to T_L - Ramp-up Rate | | 3°C/sec. Max |
| Reflow | -Temperature(T_L)(Liquidus) | +217°C |
| | -Temperature(t_L) | 60-150 secs. |
| Peak Temp (T_p) | | +260(+0/-5)°C |
| Time within 5°C of actual Peak Temp (t_p) | | 20-40secs. |
| Ramp-down Rate | | 6°C/sec. Max |
| Time 25°C to Peak Temp (T_p) | | 8 min. Max |
| Do not exceed | | +260°C |



ORDERING INFORMATION

| Order code | Voltage V_{DRM}/V_{RRM} (V) | IGT(mA) | Package | Base qty. (pcs) | Delivery mode |
|--------------|----------------------------------|--------------|---------|--------------------|---------------|
| | | I - II - III | | | |
| T2050H-6E | 600 | 50 | TO-263 | 50 | Tube |
| T2050H-6E-TR | | | | 800 | Tape & Reel |

Document Revision History

| Date | Revision | Changes |
|--------------|----------|--------------|
| Apr.10, 2023 | A.1.0 | Last updated |

PACKAGE MECHANICAL DATA

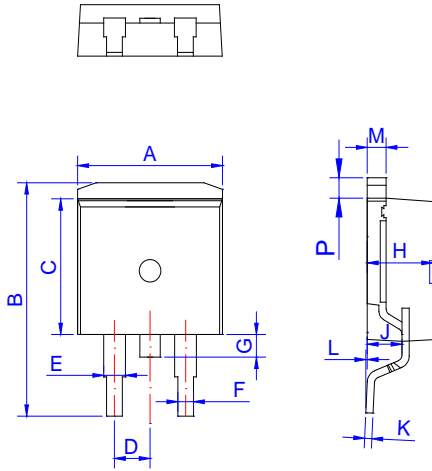

| Ref. | Dimensions | | | | | |
|------|-------------|------|-------|--------|-------|-------|
| | Millimeters | | | Inches | | |
| | Min. | Typ. | Max. | Min. | Typ. | Max. |
| A | 9.90 | | 10.20 | 0.390 | | 0.402 |
| B | 14.70 | | 15.80 | 0.579 | | 0.622 |
| C | 9.40 | | 9.60 | 0.37 | | 0.378 |
| D | 2.40 | | 2.70 | 0.094 | | 0.106 |
| E | 1.20 | | 1.50 | 0.047 | | 0.059 |
| F | 0.75 | | 0.85 | 0.029 | | 0.033 |
| G | 1.00 | | 1.50 | 0.039 | | 0.059 |
| H | 4.40 | | 4.70 | 0.173 | | 0.185 |
| J | 2.30 | | 2.70 | 0.091 | | 0.106 |
| K | 0.38 | | 0.55 | 0.015 | | 0.022 |
| L | 0 | 0.10 | 0.25 | 0 | 0.004 | 0.010 |
| M | 1.25 | | 1.35 | 0.049 | | 0.053 |
| P | 1.20 | | 1.50 | 0.047 | | 0.059 |

FOOTPRINT-TO-263 (dimensions in mm)

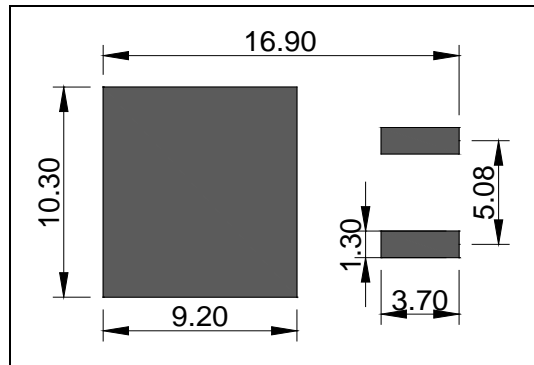

DELIVERY MODE

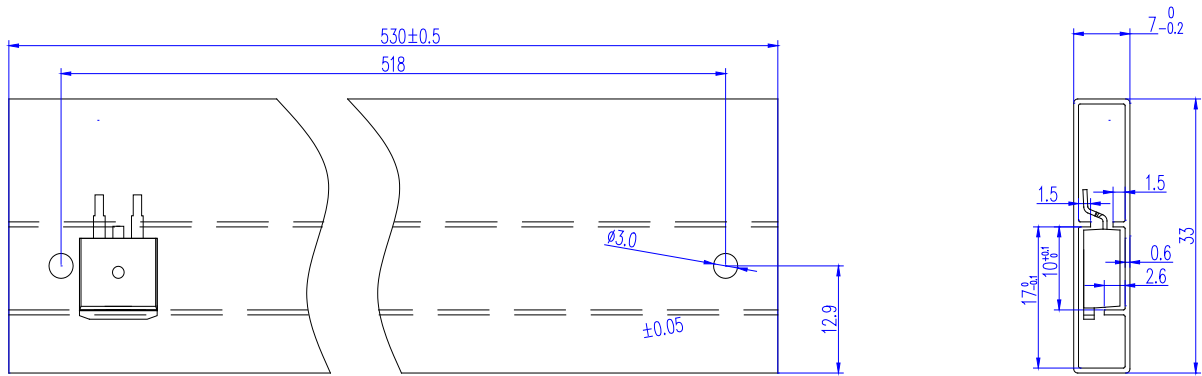

| PACKAGE | OUTLINE | TUBE (PCS) | INNER BOX (PCS) | PER CARTON |
|---------|---------|------------|-----------------|------------|
| TO-263 | TUBE | 50 | 1,000 | 5,000 |



| Ref. | Dimensions | | | | | |
|------|-------------|-------|-------|--------|-------|-------|
| | Millimeters | | | Inches | | |
| | Min. | Typ. | Max. | Min. | Typ. | Max. |
| W | 23.70 | 24.00 | 24.30 | 0.933 | 0.945 | 0.957 |
| E | 1.65 | 1.75 | 1.85 | 0.065 | 0.069 | 0.073 |
| F | 11.40 | 11.50 | 11.60 | 0.449 | 0.453 | 0.457 |
| D0 | - | 1.50 | 1.60 | - | 0.059 | 0.063 |
| D1 | - | 1.50 | 1.60 | - | 0.059 | 0.063 |
| P0 | 3.90 | 4.00 | 4.10 | 0.154 | 0.157 | 0.161 |
| P1 | 15.90 | 16.00 | 16.10 | 0.626 | 0.630 | 0.634 |
| P2 | 1.90 | 2.00 | 2.10 | 0.075 | 0.079 | 0.083 |
| A0 | 10.80 | 10.90 | 11.00 | 0.425 | 0.429 | 0.433 |
| B0 | 16.20 | 16.30 | 16.40 | 0.638 | 0.642 | 0.646 |
| K0 | 4.80 | 4.90 | 5.00 | 0.189 | 0.193 | 0.197 |
| t | 0.35 | 0.40 | 0.45 | 0.014 | 0.016 | 0.018 |

| PACKAGE | OUTLINE | REEL (PCS) | PER CARTON (PCS) | TAPE & REEL |
|---------|---------|------------|------------------|-------------|
| TO-263 | TAPING | 800 | 4,000 | 13 inch |

Information furnished in this document is believed to be accurate and reliable. However, Jiangsu JieJie Microelectronics Co., Ltd. assumes no responsibility for the consequences of use without consideration for such information nor use beyond it. Information mentioned in this document is subject to change without notice, apart from that when an agreement is signed, Jiangsu JieJie complies with the agreement.

Products and information provided in this document have no infringement of patents. Jiangsu JieJie assumes no responsibility for any infringement of other rights of third parties which may result from the use of such products and information. This document supersedes and replaces all information previously supplied.

 is a registered trademark of Jiangsu JieJie Microelectronics Co., Ltd.

Copyright © 2023 Jiangsu JieJie Microelectronics Co., Ltd. All rights reserved.